



SHARP®

OPERATION MANUAL

MODEL

PG-M25X

Introduction

Setup and Connections

Basic Operation

Easy to Use Functions

Appendix



DIGITAL MULTIMEDIA PROJECTOR



香港電器安全規格
(國際電工委員會規格適合)





IMPORTANT

For your assistance in reporting the loss or theft of your Projector, please record the Serial Number located on the bottom of the projector and retain this information. Before recycling the packaging, please be sure that you have checked the contents of the carton thoroughly against the list of "Supplied accessories" on page 20.

Model No.: PG-M25X

Serial No.:

This equipment complies with the requirements of Directives 89/336/EEC and 73/23/EEC as amended by 93/68/EEC.

Dieses Gerät entspricht den Anforderungen der EG-Richtlinien 89/336/EWG und 73/23/EWG mit Änderung 93/68/EWG.

Ce matériel répond aux exigences contenues dans les directives 89/336/CEE et 73/23/CEE modifiées par la directive 93/68/CEE.

Dit apparaat voldoet aan de eisen van de richtlijnen 89/336/EEG en 73/23/EEG, gewijzigd door 93/68/EEG.

Dette udstyr overholder kravene i direktiv nr. 89/336/EEC og 73/23/EEC med tillæg nr. 93/68/EEC.

Quest' apparecchio è conforme ai requisiti delle direttive 89/336/EEC e 73/23/EEC, come emendata dalla direttiva 93/68/EEC.

Η εγκατάσταση αυτή ανταποκρίνεται στις απαιτήσεις των οδηγιών της Ευρωπαϊκής Ένωσης 89/336/EOK και 73/23/EOK, όπως οι κανονισμοί αυτοί συμπληρώθηκαν από την οδηγία 93/68/EOK.

Este equipamento obedece às exigências das directivas 89/336/CEE e 73/23/CEE, na sua versão corrigida pela directiva 93/68/CEE.

Este aparato satisface las exigencias de las Directivas 89/336/CEE y 73/23/CEE, modificadas por medio de la 93/68/CEE.

Denna utrustning uppfyller kraven enligt riktlinjerna 89/336/EEC och 73/23/EEC så som kompletteras av 93/68/EEC.

Dette produktet oppfyller betingelsene i direktivene 89/336/EEC og 73/23/EEC i endringen 93/68/EEC.

Tämä laite täyttää direktiivien 89/336/EEC ja 73/23/EEC vaatimukset, joita on muutettu direktiivillä 93/68/EEC.

GyroRemote

This equipment complies with the requirements of Directive 1999/5/EC.

GyroRemote-Fernbedienung

Dieses Gerät entspricht den Anforderungen der EU-Richtlinie 1999/5/EG.

GyroRemote

Cet appareil est conforme aux exigences de la directive 1999/5/CE.

GyroRemote

Dit apparaat voldoet aan de eisen van de richtlijn 1999/5/EG.

GyroFjernbetjening

Dette udstyr overholder kravene i direktiv 1999/5/EF.

GyroRemote

Quest' apparecchio è conforme ai requisiti delle direttiva 1999/5/CE.

Γυροσκοπικό Τηλεχειριστήριο

Η συσκευή αυτή εναρμονίζεται με τις απαιτήσεις της οδηγίας 1999/5/EK.

GyroRemoto

Este equipamento obedece às exigências da directiva 1999/5/CE.

GyroRemote

Este aparato satisface las exigencias de las Directiva 1999/5/CE.

Gyrofjärrkontroll

Denna utrustning uppfyller kraven enligt direktiv 1999/5/EC.

GyroRemote

Dette produktet oppfyller kravene i direktiv 1999/5/EC.

Gyro-kauko-ohjain

Tämä laite täyttää direktiivin 1999/5/EY vaatimukset.



SHARP

DECLARATION OF CONFORMITY *Konformitätserklärung* *Declaration de Conformité*



We, SHARP Electronics (Europe) GmbH, SonninstraÙe 3, 20097 Hamburg
Wir, SHARP Electronics (Europe) GmbH, SonninstraÙe 3, 20097 Hamburg, Deutschland
Nous, SHARP Electronics (Europe) GmbH, SonninstraÙe 3, 20097 Hamburg, Allemagne

Declare that the following product(s)

erklaren hiermit, daÙ das/die folgende(n) Produkt(e):
Dclarons que le(s) produit(s) suivant(s):

Type of Equipment: Remote Control

Typ
Type

Model Number(s): RRMCG 1653CESA

Modell Nummer(n):
Numro de modle:

Conform(s) to the following Directives and Standards:

den folgenden Richtlinien und Standards entspricht/entsprechen:
est/sont conforme(s) aux directives et normes suivantes:

Council Directive(s) 1999/5/EC

Richtlinie(n) des Rates 1999/5/EG
Directive du Conseil 1999/5/CE

Applied Standards: EN 60950
EN 300220-3
ETS 300683

Angewandte Standards:
Normes appliquees:

CE Mark affixed on the product: 2001

CE-Kennzeichnung auf dem Produkt angebracht:
Marquage CE appose sur le produit:

Signature:

Unterschrift:
Signature:

Place: Hamburg

Ort:
Lieu:

Full name: ppa. Dr. Wolfram Konertz **Date: 21.05.2001**

Vollstndiger Name:
Nom:



Datum:
Date:

Position: Director, Human Resources and General Services
Sharp Electronics (Europe) GmbH

Position:
Fonction:



SPECIAL NOTE FOR USERS IN THE U.K.

The mains lead of this product is fitted with a non-rewireable (moulded) plug incorporating a 13A fuse. Should the fuse need to be replaced, a BSI or ASTA approved BS 1362 fuse marked  or  and of the same rating as above, which is also indicated on the pin face of the plug, must be used.

Always refit the fuse cover after replacing the fuse. Never use the plug without the fuse cover fitted.

In the unlikely event of the socket outlet in your home not being compatible with the plug supplied, cut off the mains plug and fit an appropriate type.

DANGER:

The fuse from the cut-off plug should be removed and the cut-off plug destroyed immediately and disposed of in a safe manner.

Under no circumstances should the cut-off plug be inserted elsewhere into a 13A socket outlet, as a serious electric shock may occur.

To fit an appropriate plug to the mains lead, follow the instructions below:

IMPORTANT:

The wires in the mains lead are coloured in accordance with the following code:

Blue: Neutral

Brown: Live

As the colours of the wires in the mains lead of this product may not correspond with the coloured markings identifying the terminals in your plug, proceed as follows:

- The wire which is coloured blue must be connected to the plug terminal which is marked N or coloured black.
- The wire which is coloured brown must be connected to the plug terminal which is marked L or coloured red.

Ensure that neither the brown nor the blue wire is connected to the earth terminal in your three-pin plug.

Before replacing the plug cover make sure that:

- If the new fitted plug contains a fuse, its value is the same as that removed from the cut-off plug.
- The cord grip is clamped over the sheath of the mains lead, and not simply over the lead wires.

IF YOU HAVE ANY DOUBT, CONSULT A QUALIFIED ELECTRICIAN.

The supplied CD-ROM contains operation instructions in English, German, French, Swedish, Spanish, Italian, Dutch, Portuguese, Chinese and Korean. Carefully read through the operation instructions before operating the projector.

Die mitgelieferte CD-ROM enthält Bedienungsanleitungen in Englisch, Deutsch, Französisch, Schwedisch, Spanisch, Italienisch, Niederländisch, Portugiesisch, Chinesisch, und Koreanisch. Bitte lesen Sie die Bedienungsanleitung vor der Verwendung des Projektors sorgfältig durch.

Le CD-ROM fourni contient les instructions de fonctionnement en anglais, allemand, français, suédois, espagnol, italien, néerlandais, portugais, chinois et coréen. Veuillez lire attentivement ces instructions avant de faire fonctionner le projecteur.

Den medföljande CD-ROM-skivan innehåller bruksanvisningar på engelska, tyska, franska, svenska, spanska, italienska, holländska, portugisiska, kinesiska och koreanska. Läs noga igenom bruksanvisningen innan projektorn tas i bruk.

El CD-ROM suministrado contiene instrucciones de operación en inglés, alemán, francés, sueco, español, italiano, holandés, portugués, chino y coreano. Lea cuidadosamente las instrucciones de operación antes de utilizar el proyector.

Il CD-ROM in dotazione contiene istruzioni per l'uso in inglese, tedesco, francese, svedese, spagnolo, italiano, olandese, portoghese, cinese e coreano. Leggere attentamente le istruzioni per l'uso prima di usare il proiettore.

De meegeleverde CD-ROM bevat handleidingen in het Engels, Duits, Frans, Zweeds, Spaans, Italiaans, Nederlands, Portugees, Chinees en Koreaans. Lees de handleiding zorgvuldig door voor u de projector in gebruik neemt.

O CD-ROM fornecido contém instruções de operação em Inglês, Alemão, Francês, Sueco, Espanhol, Italiano, Holandês, Português, Chinês e Coreano. Leia cuidadosamente todas as instruções de operação antes de operar o projetor.

附送之CD-ROM光碟中，有用英文、德文、法文、瑞典文、西班牙文、意大利文、荷蘭文、葡萄牙文、中文、和韓國文所寫的使用說明書。在操作本投影機之前，請務必仔細閱讀整本使用說明書。

제공된 CD-ROM에는 영어, 독일어, 프랑스어, 스웨덴어, 스페인어, 이탈리아어, 덴마크어, 포르투갈어, 중국어(번체자와 간체자), 한국어, 그리고 아랍어로 작성된 조작 설명서가 포함되어 있습니다. 프로젝터를 조작하기 전에 조작 지침을 상세 하게 숙지하십시오.



Before using the projector, please read this operation manual carefully.

Introduction ENGLISH

There are two important reasons for prompt warranty registration of your new SHARP Projector, using the REGISTRATION CARD packed with the projector.

1. WARRANTY

This is to assure that you immediately receive the full benefit of the parts, service and labor warranty applicable to your purchase.

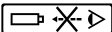

2. CONSUMER PRODUCT SAFETY ACT

To ensure that you will promptly receive any safety notification of inspection, modification, or recall that SHARP may be required to give under the 1972 Consumer Product Safety Act, PLEASE READ CAREFULLY THE IMPORTANT "LIMITED WARRANTY" CLAUSE. U.S.A. ONLY

WARNING: High brightness light source. Do not stare into the beam of light, or view directly. Be especially careful that children do not stare directly into the beam of light. 

WARNING: To reduce the risk of fire or electric shock, do not expose this product to rain or moisture.

See bottom of actual set.

	CAUTION RISK OF ELECTRIC SHOCK. DO NOT REMOVE SCREWS EXCEPT SPECIFIED USER SERVICE SCREWS.	
CAUTION: TO REDUCE THE RISK OF ELECTRIC SHOCK, DO NOT REMOVE COVER. NO USER-SERVICEABLE PARTS EXCEPT LAMP UNIT. REFER SERVICING TO QUALIFIED SERVICE PERSONNEL.		



The lightning flash with arrowhead symbol, within an equilateral triangle, is intended to alert the user to the presence of uninsulated "dangerous voltage" within the product's enclosure that may be of sufficient magnitude to constitute a risk or electric shock to persons.



The exclamation point within a triangle is intended to alert the user to the presence of important operating and maintenance (servicing) instructions in the literature accompanying the product.

WARNING: FCC Regulations state that any unauthorized changes or modifications to this equipment not expressly approved by the manufacturer could void the user's authority to operate this equipment. U.S.A. ONLY

INFORMATION

This equipment has been tested and found to comply with the limits for a Class A digital device, pursuant to Part 15 of the FCC Rules. These limits are designed to provide reasonable protection against harmful interference when the equipment is operated in a commercial environment. This equipment generates, uses, and can radiate radio frequency energy and, if not installed and used in accordance with the operation manual, may cause harmful interference to radio communications. Operation of this equipment in a residential area is likely to cause harmful interference, in which case the user will be required to correct the interference at his own expense. U.S.A. ONLY

The enclosed computer cable must be used with the device. The cable is provided to ensure that the device complies with FCC Class A verification. U.S.A. ONLY

WARNING:

This is a Class A product. In a domestic environment this product may cause radio interference in which case the user may be required to take adequate measures.



"Operation is subject to the following two conditions: (1) this device may not cause interference, and (2) this device must accept any interference, including interference that may cause undesired operation of the device".

CANADA ONLY

For GyroRemote unit (RRMCG1631CESA)

This device complies with part 15 of the FCC rules. Operation is subject to the following two conditions:

- (1) This device may not cause harmful interference, and
 - (2) This device must accept any interference received, including interference that may cause undesired operation.
- This device operates in the frequency band of 49.82 to 49.90 MHz with RF output power of less than 30 MicroWatts EIRP (Effective Isotropic Radiated Power).

Caution

Any changes made to this device not expressly approved by the manufacturer could void the users right to operate this device.

U.S.A. ONLY

WARNING:

The cooling fan in this projector continues to run for about 90 seconds after the projector is turned off. During normal operation, when turning the power off always use the **POWER** button on the projector or on the remote control. Ensure the cooling fan has stopped before disconnecting the power cord.

DURING NORMAL OPERATION, NEVER TURN THE PROJECTOR OFF BY DISCONNECTING THE POWER CORD. FAILURE TO OBSERVE THIS WILL RESULT IN PREMATURE LAMP FAILURE.

PRODUCT DISPOSAL

This projector utilizes tin-lead solder, and a pressurized lamp containing a small amount of mercury. Disposal of these materials may be regulated due to environmental considerations. For disposal or recycling information, please contact your local authorities or, if you are located in the United States of America, the Electronic Industries Alliance: www.eiae.org.

Caution Concerning the Lamp Replacement

See "Replacing the Lamp" on page 111.

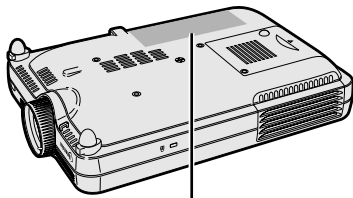

⚠ LAMP REPLACEMENT CAUTION
 BEFORE REMOVING THE SCREW, DISCONNECT POWER CORD.
 HOT SURFACE INSIDE. ALLOW 1 HOUR TO COOL BEFORE REPLACING THE LAMP.
 REPLACE WITH SAME SHARP LAMP UNIT TYPE BQC-PGM20X//1 ONLY.
 UV RADIATION : CAN CAUSE EYE DAMAGE. TURN OFF LAMP BEFORE SERVICING.
 MEDIUM PRESSURE LAMP : RISK OF EXPLOSION. POTENTIAL HAZARD OF GLASS PARTICLES IF LAMP HAS RUPTURED. HANDLE WITH CARE. SEE OPERATION MANUAL.

⚠ PRECAUTIONS A OBSERVER LORS DU REMPLACEMENT DE LA LAMPE.
 DEBRANCHER LE CORDON D'ALIMENTATION AVANT DE RETIRER LES VIS.
 L'INTERIEUR DU BOITIER ETANT EXTREMEMENT CHAUD, ATTENDRE 1 HEURE AVANT DE PROCEDER AU REMPLACEMENT DE LA LAMPE.
 NE REMPLACER QUE PAR UNE LAMPE SHARP DE TYPE BQC-PGM20X//1.
 RAYONS ULTRAVIOLETS : PEUVENT ENDOMMAGER LES YEUX.
 ETEINDRE LA LAMPE AVANT DE PROCEDER A L'ENTRETIEN.
 LAMPE A MOYENNE PRESSION : RISQUE D'EXPLOSION. DANGER POTENTIEL DE PARTICULES DE VERRE EN CAS D'ECLATEMENT DE LA LAMPE
 A MANIPULER AVEC PRECAUTION, SE REPORTER AU MODE D'EMPLOI.



Outstanding Features

1. Image Quality

- Superior image quality with Fujinon™ optical lens system.
- Newly developed DDR (Double Data Rate) chip eliminates Color Breaking phenomena common with previous generation DLP™ projectors.
- Newly developed 12° DMD™ chip provides significantly improved optical efficiency and excellent contrast ratio.

2. Light, Compact, and Unique Slim Design

- A new optical engine creates a unique slim design and compact size (4.2 liters, 5.8 lbs. (2.6 kg)).

3. Superior PC Compatibility

- Supports a refresh rate (vertical frequency) of up to 200 Hz and a wide range of synchronous signals.
- Using Advanced Compression Technology, computer screens of UXGA (1,600 × 1,200) resolution can be displayed with minimal distortion.

4. Advanced Computer & Video Integrated Composer Technology

- **Realizes vivid images using the latest high image quality circuitry.**
 - **New I/P conversion algorithm enhances the performance of the motion detect I/P conversion.**
Extensive improvements on the jagged edges or slanted lines in moving images.
 - **Contrast Control Dynamic Gamma**
Improved contrast and natural color gradation by minimizing hue change.
 - **Color Management Function**
Supports sRGB (color management).
 - **Noise Reduction**
Allows for a clear image even with noisy source signals.
 - **New Edge Up-Scaling**
Reduces jaggies and flickering when up-scaling edges of slanted lines, enabling sharper quality images.

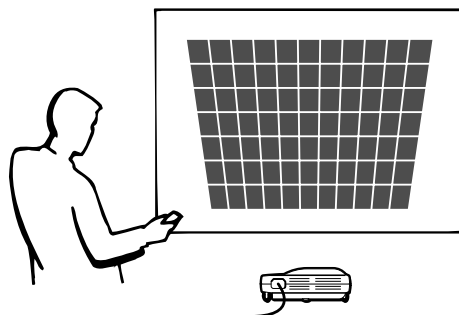



6. Built-in PCMCIA card slot (Type II)

- **Wireless presentations using a wireless LAN PC card.**

Supports the global wireless LAN standard, IEEE802.11b.

This wireless LAN PC card complies with IEEE802.11b wireless LAN standards.

Computers with built-in wireless LAN PC cards that support this standard allow for wireless connections.



Note

- A wireless connection with all IEEE802.11b compliant computers is not guaranteed.

The projector or computer can be placed anywhere you want!

You can expand your presentation efficiency through a wireless connection, for example, by projecting computer images through a projector installed on the ceiling.

You can display images from a computer selected from a group of computers.

Effective presentations can now be realized without having to reconnect data cables all the time.

- **PC-less presentations using a memory card.**

Just by inserting an IC media (a memory card) such as CompactFlash in the projector using a PCMCIA card (Type II) adapter, you can make presentations or auto demonstrations without using a computer.



Note

- For wireless presentations using the wireless LAN PC card, as well as PC-less presentations using memory cards, please refer to the Wireless Reality operation manual.

7. GyroRemote

- **Using the Gyro function, you can realize more effective and advanced presentations.**
- **The crisp screen pointer gives your presentations a more intuitive touch.**
- **Using the multi-directional wireless remote control, your transmission range can be expanded, as well as perform the same operations as a USB mouse on a computer.**



Contents

Introduction

- Outstanding Features 3**
- Contents 5**
- IMPORTANT SAFEGUARDS 8**
- How to Access the PDF Operation Manuals**
- (Windows, Macintosh) 13**
- Part Names 14**
- Projector (Front and Top View) 14
- Projector (Side View) 15
- GyroRemote 16
- Inserting the Batteries 17
- Replacing the Batteries 17
- The GyroRemote 18**
- GyroRemote Features 18
- Calibrating the GyroRemote 19
- Accessories 20**

Setup and Connections

- Setup 22**
- Using the Adjustment Feet 22
- Setting up the Screen 23
- Screen Size and Projection Distance 24
- Projecting a Reversed/Inverted Image 25
- Connecting the Projector to Other Devices 26**
- Before Connecting 26
- Connecting the Power Cord 26
- Connecting the Projector to a Computer 27
- Connecting to Video Equipment 29
- Installing / Removing the PC Card 31
- Connecting to a Monitor 32

Basic Operation

- Image Projection 34**
- Basic Procedure 34
- Selecting the On-screen Display Language 37
- Adjusting the Lens 37
- Correcting the Trapezoidal Distortion**
- (Keystone Correction) 38**
- Correcting the Trapezoidal Distortion 38
- Using the GyroRemote 40**
- Before Using the GyroRemote 40

- Gesture Operation
- (Selecting OSD Menus, Operating Presentation
- Tools) 40
- Function Assign 41
- GyroRemote Channel Setting 42
- Registering the GyroRemote in the Projector 42
- Registering Multiple GyroRemotes in One Projector 43
- Using the Presentation Tools 44**
- Using the Pointer 44
- Using the Stamp Function 45
- Using the Line Function 46
- Using the Wireless Presentation Function**
- of the GyroRemote 47**
- Connecting the
- Computer and the Projector 47
- Using as a Wireless Mouse 48
- Connecting the GyroRemote with a Cable 48
- Turning Off the GyroRemote 49
- Using the Menu Screen 50**
- Menu Selections on the Projector (Adjustments) 50
- Menu Selections on the projector (Settings) 52
- Using the GyroRemote to Navigate the On-screen
- Menu (Adjustments) 54
- Using the GyroRemote to Navigate the On-screen
- Menu (Settings) 55
- Menu Bar Items 56**
- Adjusting the Picture 59**
- Adjusting Image Preferences 59
- Selecting the Signal Type 59
- Progressive Mode 60
- Adjusting Computer Images 61**
- When Auto Sync is OFF 61
- Saving Adjustment Settings 61
- Selecting Adjustment Settings 62
- Special Mode Settings 62
- Checking the Input Signal 63
- Auto Sync Adjustment 63
- Auto Sync Display Function 64

Easy to Use Functions

- Using the Network 66**
- Before setting the network 66
- Using a Wireless LAN PC Card 68**
- Installing a Wireless LAN PC Card 68
- Ejecting the Card 68



Network Settings	69	Capturing the Image	94
Setting Up a Projector Name	69	Deleting the Captured Image	94
Setting the IP Address	70	Setting a Background Image	95
Setting the Wireless Channel	71	Selecting a Background Image	95
Setting the SSID	72	Using an RGB Monitor Loop-out Adaptor	96
Setting the DHCP Server	73	Using an RGB Monitor Loop-out Adaptor	96
Resetting the Network Settings	74	Displaying the Lamp Usage Time	96
Wireless LAN PC card: Troubleshooting	74	Confirming the Lamp Usage Time	96
Using a Memory Card	75	Displaying the Break Timer	97
Displaying of the Contents in the Card as an Index	75	Displaying and Setting the Break Timer	97
Ejecting the Card	75	To cancel the break time	97
Setting the Thumbnail Display	76	Reversing/Inverting Projected Images	98
Setting Lists	77	Setting the Projection Mode	98
Memory Card Settings	78	Locking the Operation Buttons	
Setting Files	78	on the Projector	99
Setting the Display Order of Files	78	Setting up the Keylock	99
Setting the Display Format of the Index Mode	79	Canceling the Keylock Setting	99
Using Autorun	79	Setting up a Password	100
Setting the Display Interval for Image Files	80	Entering the Password	100
Displaying a Still Image	81	Changing the Password	101
Storing an Image in Still Image Format	81	If You Forget Your Password	101
Selecting the Picture Display Mode	82	Setting the Anti-Theft	102
Switching the Picture Display Using Different Input		Entering the Keycode	102
Signals	82	Changing the Keycode	104
Enlarging a Specific Portion of an Image	84	Initializing the Settings	105
Displaying an Enlarged Portion of an Image	84	Returning to the Default Settings	105
Gamma Correction Function	86	Displaying the Adjustment Settings	106
Adjusting Gamma Correction	86	Overview of ALL Menu Settings	106
Selecting the Power Save Mode	87		
Setting the Power Save Mode	87	Appendix	
Automatic Power Shutoff Function	87	Carrying the Projector	108
Displaying Dual Pictures (Pict in Pict)	88	How to Use the Carrying Case	108
Displaying the Inset Picture	88	Maintenance	109
Setting On-screen Display	89	Maintenance Indicators	110
Turning Off the On-screen Display	89	Regarding the Lamp	111
Activating the sRGB Color		Lamp	111
Management Function	90	Caution Concerning the Lamp	111
Setting the Color Management Function (sRGB)	90	Replacing the Lamp	111
Auto Search Function	91	Removing and Installing the Lamp Unit	112
Using Auto Search	91	Resetting the Lamp Timer	113
Video Digital Noise Reduction (DNR) System	92	Connecting Pin Assignments	114
Reducing Image Noise	92	Computer Compatibility Chart	115
Setting the Video Signal	93	Troubleshooting	116
Selecting a Startup Image	93	For SHARP Assistance	118
Selecting a Startup Image	93	Specifications	119
Saving Projected Images	94		



Wireless LAN PC Card Specification 120
Usable Cards and Their Capacity 121
Dimensions 122
Glossary 123
Index 125



IMPORTANT SAFEGUARDS

CAUTION: Please read all of these instructions before you operate this product and save these instructions for later use.

Electrical energy can perform many useful functions. This product has been engineered and manufactured to assure your personal safety. BUT IMPROPER USE CAN RESULT IN POTENTIAL ELECTRICAL SHOCK OR FIRE HAZARDS. In order not to defeat the safeguards incorporated in this product, observe the following basic rules for its installation, use and servicing.

1. Read Instructions

All the safety and operating instructions should be read before the product is operated.

2. Retain Instructions

The safety and operating instructions should be retained for future reference.

3. Heed Warnings

All warnings on the product and in the operating instructions should be adhered to.

4. Follow Instructions

All operating and use instructions should be followed.

5. Cleaning

Unplug this product from the wall outlet before cleaning. Do not use liquid cleaners or aerosol cleaners. Use a damp cloth for cleaning.

6. Attachments

Do not use attachments not recommended by the product manufacturer as they may cause hazards.

7. Water and Moisture

Do not use this product near water—for example, near a bath tub, wash bowl, kitchen sink, or laundry tub; in a wet basement; or near a swimming pool; and the like.

8. Accessories

Do not place this product on an unstable cart, stand, tripod, bracket, or table. The product may fall, causing serious injury to a child or adult, and serious damage to the product. Use only with a cart, stand, tripod, bracket, or table recommended by the manufacturer, or sold with the product. Any mounting of the product should follow the manufacturer's instructions, and should use a mounting accessory recommended by the manufacturer.

9. Transportation

A product and cart combination should be moved with care. Quick stops, excessive force, and uneven surfaces may cause the product and cart combination to overturn.



10. Ventilation

Slots and openings in the cabinet are provided for ventilation to ensure reliable operation of the product and to protect it from overheating, and these openings must not be blocked or covered. The openings should never be blocked by placing the product on a bed, sofa, rug, or other similar surface. This product should not be placed in a built-in installation such as a bookcase or rack unless proper ventilation is provided or the manufacturer's instructions have been adhered to.

11. Power Sources

This product should be operated only from the type of power source indicated on the marking label. If you are not sure of the type of power supply to your home, consult your product dealer or local power company. For products intended to operate from battery power, or other sources, refer to the operating instructions.

12. Grounding or Polarization

This product is provided with one of the following types of plugs. If the plug should fail to fit into the power outlet, please contact your electrician.

Do not defeat the safety purpose of the plug.

- Two-wire type (mains) plug.
- Three-wire grounding type (mains) plug with a grounding terminal.

This plug will only fit into a grounding type power outlet.

13. Power-Cord Protection

Power-supply cords should be routed so that they are not likely to be walked on or pinched by items placed upon or against them, paying particular attention to cords at plugs, convenience receptacles, and the point where they exit from the product.

14. Lightning

For added protection for this product during a lightning storm, or when it is left unattended and unused for long periods of time, unplug it from the wall outlet and disconnect the cable system. This will prevent damage to the product due to lightning and power-line surges.

15. Overloading

Do not overload wall outlets, extension cords, or integral convenience receptacles as this can result in a risk of fire or electric shock.

16. Object and Liquid Entry

Never push objects of any kind into this product through openings as they may touch dangerous voltage points or short-out parts that could result in a fire or electric shock. Never spill liquid of any kind on the product.

17. Servicing

Do not attempt to service this product yourself as opening or removing covers may expose you to dangerous voltage or other hazards. Refer all servicing to qualified service personnel.



18. Damage Requiring Service

Unplug this product from the wall outlet and refer servicing to qualified service personnel under the following conditions:

- a. When the power-supply cord or plug is damaged.
- b. If liquid has been spilled, or objects have fallen into the product.
- c. If the product has been exposed to rain or water.
- d. If the product does not operate normally by following the operating instructions. Adjust only those controls that are covered by the operating instructions, as an improper adjustment of other controls may result in damage and will often require extensive work by a qualified technician to restore the product to normal operation.
- e. If the product has been dropped or damaged in any way.
- f. When the product exhibits a distinct change in performance, this indicates a need for service.

19. Replacement Parts

When replacement parts are required, be sure the service technician has used replacement parts specified by the manufacturer or have the same characteristics as the original part. Unauthorized substitutions may result in fire, electric shock, or other hazards.

20. Safety Check

Upon completion of any service or repairs to this product, ask the service technician to perform safety checks to determine that the product is in proper operating condition.

21. Wall or Ceiling Mounting

This product should be mounted to a wall or ceiling only as recommended by the manufacturer.

22. Heat

This product should be situated away from heat sources such as radiators, heat registers, stoves, or other products (including amplifiers) that produce heat.

IMPORTANT SAFEGUARDS (cont.)

INTELLECTUAL PROPERTY RIGHTS IMPORTANT READ BEFORE USING THE PRODUCT

- You have acquired a product that includes software licensed to SHARP Corporation by Lineo, Inc. (“Lineo”). The Software is protected by copyright laws, international copyright treaties, and other intellectual property laws and treaties. Lineo and its suppliers retain all ownership of, and intellectual property rights in (including copyright), the Software components and all copies thereof, provided however, that certain components of the Software are components licensed under the GNU General Public License (version 2), which Lineo supports. You may obtain a copy of the GNU General Public License at <http://www.fsf.org/copyleft/gpl.html>. Lineo will provide source code for any of the components of the Software licensed under the GNU General Public License. To obtain such source code, send email to embedix-support@lineo.com.
- OS: Embedix (Embedded Linux) Embedix (TM) is a registered trademark of U.S.A. LINEO, Inc.
- DLP™ (Digital Light Processing) and DMD™ (Digital Micromirror Device) are trademarks of Texas Instruments, Inc.
- Microsoft and Windows are registered trademarks of Microsoft Corporation, in the United States and/or other countries.
- PC/AT is a registered trademark of International Business Machines Corporation in the United States.
- Adobe Acrobat is a trademark of Adobe Systems Incorporated.
- Macintosh is a registered trademark of Apple Computer, Inc. in the United States and/or other countries.
- All other company or product names are trademarks or registered trademarks of their respective companies.
- Some IC chips in this product include confidential and/or trade secret property belonging to Texas Instruments. Therefore you may not copy, modify, adapt, translate, distribute, reverse engineer, reverse assemble or discompile the contents thereof.



Be sure to read the following safeguards when setting up your projector.

Caution concerning the lamp unit

- Potential hazard of glass particles if lamp ruptures. In case of lamp rupture, contact your nearest Sharp Authorized Projector Dealer or Service Center for a replacement. See "Replacing the Lamp" on page 71.

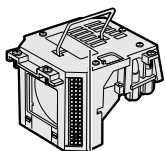

Cautions concerning the setup of the projector

- For minimal servicing and to maintain high image quality, SHARP recommends that this projector be installed in an area free from humidity, dust and cigarette smoke. When the projector is subjected to these environments, the lens must be cleaned more often. As long as the projector is regularly cleaned, use in these environments will not reduce the overall operation life of the unit. Internal cleaning should only be performed by a Sharp Authorized Projector Dealer or Service Center.

Do not set up the projector in places exposed to direct sunlight or bright light.

- Position the screen so that it is not in direct sunlight or room light. Light falling directly on the screen washes out the colors, making viewing difficult. Close the curtains and dim the lights when setting up the screen in a sunny or bright room.

The projector may safely be tilted to a maximum angle of 10 degrees.

- Placement should be within ± 10 degrees.

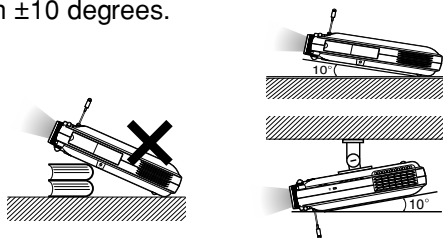

Do not subject the projector to hard impact and/or vibration.

- Take care with the lens so as not to hit or damage the surface of the lens.

Rest your eyes occasionally.

- Continuously watching the screen for long hours will make your eyes tired. Be sure to rest your eyes sometimes.

Avoid locations with high or low temperature.

- The operating temperature for the projector is from 41°F to 95°F (+5°C to +35°C)
- The storage temperature for the projector is from -4°F to 140°F (-20°C to +60°C)

Do not block the exhaust and intake vents.

- Allow at least 11.8 inches (30 cm) of space between the exhaust vent and the nearest wall or obstruction.
- Be sure that the intake vent and the exhaust vent are not obstructed.
- If the cooling fan becomes obstructed, a protection circuit will automatically turn off the projector. This does not indicate a malfunction. Remove the projector power cord from the wall outlet and wait at least 10 minutes. Place the projector where the intake and exhaust vents are not blocked, plug the power cord back in and turn on the projector. This will return the projector to the normal operating condition.

Cautions regarding the transportation of the projector

- When transporting the projector, be sure not to subject it to hard impact and/or vibration, as this can result in damage. Take extra caution with the lens. Before moving the projector, be sure to retract the antenna and the card eject button. Also, be sure to unplug the power cord from the wall outlet, disconnect any other cables connected to it and retract the antenna.

IMPORTANT SAFEGUARDS (cont.)

Other connected equipment

- When connecting a computer or other audio-visual equipment to the projector, make the connections **AFTER** turning off the projector and the equipment to be connected.
- Please read the operation manuals of the projector and the equipment to be connected for instructions on how to make the connections.

Using the projector in other countries

- The power supply voltage and the shape of the plug may vary depending on the region or country you are using the projector in. When using the projector overseas, be sure to use the appropriate power cord for the country you are in.

Temperature monitor function

- If the projector starts to overheat due to setup problems or blockage of the air vents, “” and “**TEMP.**” will blink in the lower left corner of the picture. If the temperature continues to rise, the lamp will turn off, the TEMPERATURE WARNING indicator on the projector will blink, and after a 90-second cooling-off period the power will shut off. Refer to “Maintenance Indicators” on page **70** for details.



Info

- The cooling fan regulates the internal temperature, and its performance is automatically controlled. The sound of the fan may change during projector operation due to changes in the fan speed. This does not indicate malfunction.
- Do not unplug the power cord during projection or cooling fan operation. This can create damage due to the rise in internal temperature, as the cooling fan also stops.



How to Access the PDF Operation Manuals (Windows, Macintosh)

PDF operation manuals in several languages are included in the CD-ROM, so that you can work with the projector, even if you do not have this manual on hand. To utilize these manuals, you need to install Adobe Acrobat Reader on your PC (Windows or Macintosh). If you have not installed Acrobat Reader yet, you can install it from the CD-ROM.

To Install Acrobat Reader from the CD-ROM

For Windows:

- ① Insert the CD-ROM in the CD-ROM drive.
- ② Double click the "My Computer" icon.
- ③ Double click the "CD-ROM" drive icon.
- ④ Double click the "acrobat" folder.
- ⑤ Double click the "windows" folder.
- ⑥ Double click the language (name of the folder) that you want to view.
- ⑦ Double click the installation program and follow the instructions on the screen.

For Macintosh:

- ① Insert the CD-ROM in the CD-ROM drive.
- ② Double click the "CD-ROM" icon.
- ③ Double click the "acrobat" icon.
- ④ Double click the language (name of the folder) that you want to view.
- ⑤ Double click the desired installation program and follow the instructions on the screen.

For other operating systems:

Please download Acrobat Reader from the Internet (<http://www.adobe.com>)

For other languages:

If you prefer using Acrobat Reader for languages other than those included in the CD-ROM, please download the appropriate version from the Internet.

Accessing the PDF Manuals

For Windows:

- ① Insert the CD-ROM in the CD-ROM drive.
- ② Double click the "My Computer" icon.
- ③ Double click the "CD-ROM" drive.
- ④ Double click the "manuals" folder.
- ⑤ Double click the language (name of the folder) that you want to view.
- ⑥ Double click the "m25x" pdf file to access the projector manuals.
Double click the "soft" pdf file to access the Wireless Reality.
Double click the "WC11b" pdf file to access the Wireless LAN PC Card manual.

For Macintosh:

- ① Insert the CD-ROM in the CD-ROM drive.
- ② Double click the "CD-ROM" icon.
- ③ Double click the "manuals" folder.
- ④ Double click the language (name of folder) that you want to view.
- ⑤ Double click the "m25x" pdf file to access the projector manuals.



Note

- If the desired pdf file cannot be opened by double clicking the mouse, start Acrobat Reader first, then specify the desired file using the "File", "Open" menu.
- See the "readme.txt" file on the CD-ROM for important information not included in this operation manual.



Part Names

Numbers in **[]** refer to the main pages in this Operation Manual where the topic is explained.

Projector (Front and Top View)

LAMP replacement indicator

Illuminates in green normally. Replace the lamp when the indicator illuminates in red.

POWER indicator

Illuminates in red, when the projector is in standby. When the power is turned on, this indicator will illuminate in green.

POWER button

Turns the power on or off.

LENS button

For adjusting Keystone or Digital Shift setting.

Adjustment buttons (▼▲▶▶)

For selecting menu items.

ENTER button

For setting items selected or adjusted on the menu.

AV MUTE button

For temporarily turning off the sound and picture.

110

110

34

38

50

50

35

110

35

50

35

51

63

37

40 GyroRemote Antenna

37 Zoom knob

22 Foot releases/Adjustment feet

For adjusting the projector's height.

14 Terminal cover

35 Speaker

18 Remote control sensor

Attaching the terminal cover

Attach the terminal cover by placing it on the side panel of the projector and pressing it into place, as shown in the illustration.

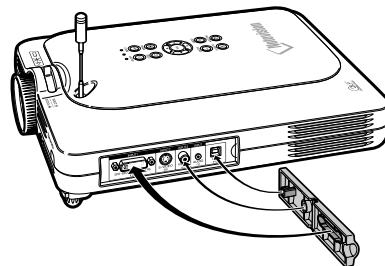



Projector (Side View)

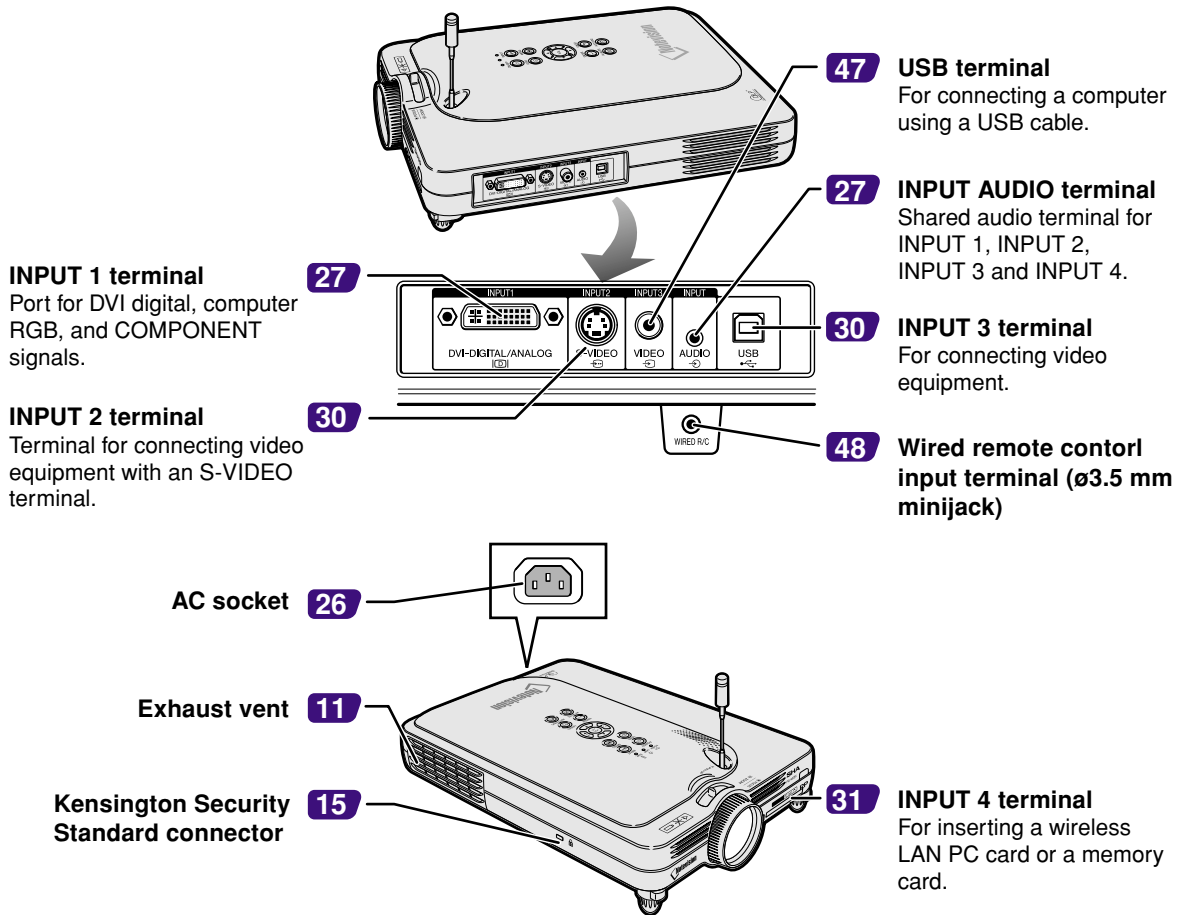

Using the Kensington Lock

- This projector has a Kensington Security Standard connector for use with a Kensington MicroSaver Security System. Refer to the information that came with the system for instructions on how to use it to secure the projector.

Attaching the lens cap

After putting the lens cap strap on the lens cap, pass the other end of the strap through the hole under the projector, next to the lens, as shown in the illustration.

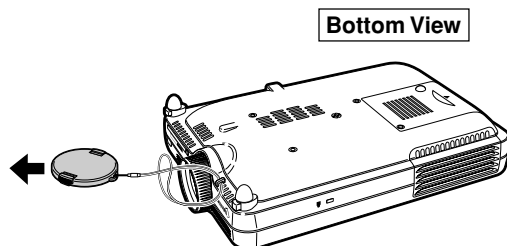
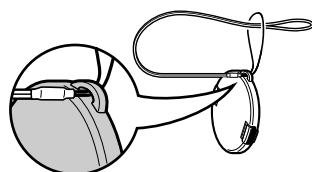



Part Names (cont.)

GyroRemote

Front

Function 1 / 2 buttons

For specifying the button assignments for Function 1 and Function 2

INPUT button

For switching between inputs 1,2,3 and 4.

L-CLICK/ ENTER button

For entering menu items or to perform a left click when using the wireless mouse.

POWER button

For turning the power on or off.

LENS button

For adjusting Keystone or Digital Shift setting.

Function 3 / 4 buttons

For specifying the button assignments for Function 3 and Function 4

TEACH (OK) button

For registering the GyroRemote in the projector.

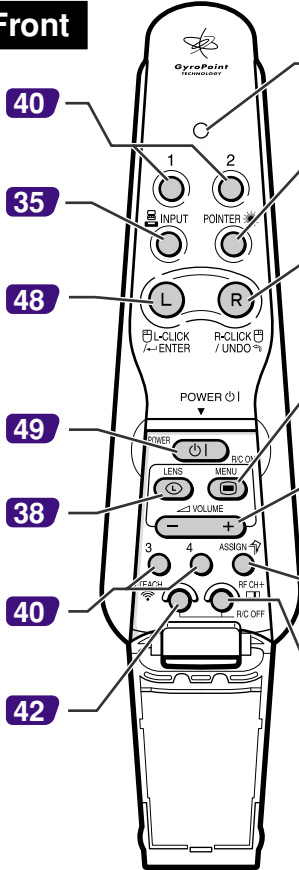

- 42 LED indicator**
Lights up when the GyroRemote is in motion.
- 44 POINTER button**
Holding this button down displays a pointer on the screen.
- 48 R-CLICK / UNDO button**
For undoing an operation or to perform a right click when using the wireless mouse.
- 54 MENU button**
For displaying adjustment and setting screens.
- 35 VOLUME buttons**
For adjusting the speaker sound level.
- 41 ASSIGN button**
Switches the button assignment function group.
- 42 RF CH+ button**
For checking the current RF channel as well as switching the channel.

Rear

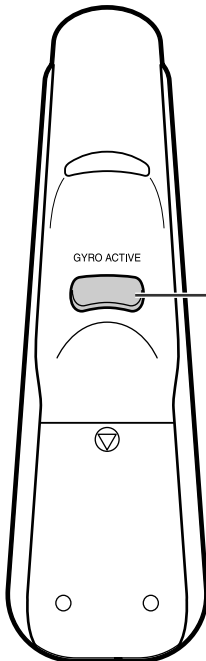

- 44 GYRO ACTIVE**
For moving the Gyro function for actions such as moving tool icons (such as stamp), selecting menus in the OSD, or moving the cursor using the wireless mouse.

Bottom

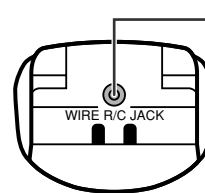

- 48 Wired remote terminal (ø2.5 mm minijack)**

Gyration U.S. Patents
5698784, 5825350, 5898421





Inserting the Batteries

The batteries (four R03 batteries ("AAA" size, UM/SUM-4, HP-16 or similar)) are included in the package.

1 Slide the cover in the direction of the arrow to open it.

2 Insert the included batteries.
• Insert the batteries making sure the polarities correctly match the \oplus and \ominus marks inside the battery compartment.

Info

- When inserting the batteries into the battery compartment of the GyroRemote, make sure that the batteries are placed over the pullstring for the easy removal in the future. If not, it may be difficult to remove old batteries when they have to be replaced.

3 Slide the cover in the direction of the arrow to close it.

Note

- GyroRemote Sleep Function
To avoid battery consumption, the GyroRemote automatically enters the Sleep mode if not action takes place within 5 minutes. If the GyroRemote cannot be operated, press once the POWER button on the GyroRemote to resume operation.

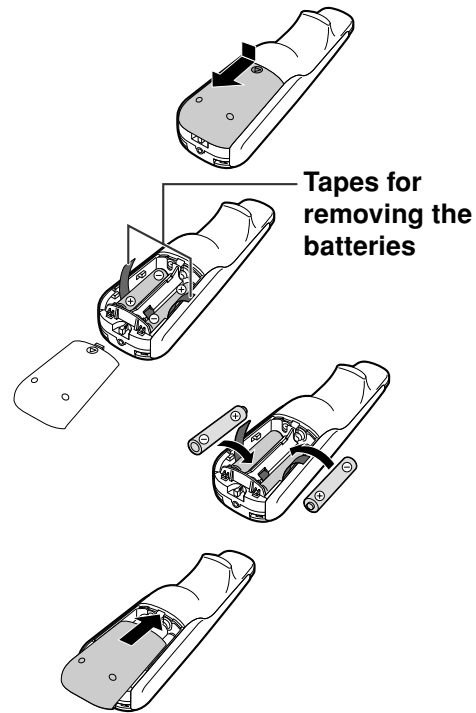

Replacing the Batteries

The LED indicator will blink when the batteries need to be replaced.

- Make sure to replace the batteries with new batteries as soon as possible when the LED indicator starts to blink.
- Be sure to use alkaline batteries.

Note

- If GyroRemote is idle for five minutes, it will go into sleep mode to conserve battery life. Pressing any button will make GyroRemote up.

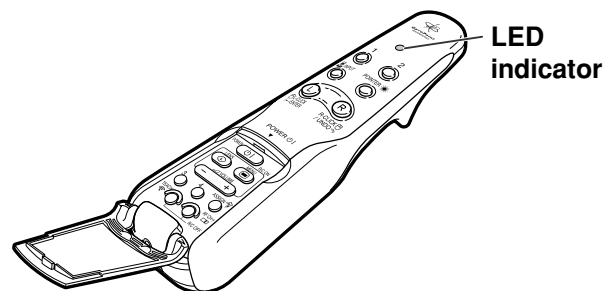

Incorrect use of the batteries may cause them to leak or explode. Please follow the precautions below.

Caution

- Insert the batteries making sure the polarities correctly match the \oplus and \ominus marks inside the battery compartment.
- Batteries of different types have different properties, therefore do not mix batteries of different types.
- Do not mix new and old batteries.
This may shorten the life of new batteries or may cause old batteries to leak.
- Remove the batteries from the remote control once they have run out, as leaving them can cause them to leak.
Battery fluid from leaked batteries is harmful to your skin, therefore be sure to first wipe them and then remove them using a cloth.

- The batteries included with this projector may be exhausted over a short period, depending on how they are kept. Be sure to replace them as soon as possible with new batteries.
- Remove the batteries from the remote control if you will not be using the remote control for a long time.



The GyroRemote

GyroRemote Features

This projector uses the GyroRemote technology, that allows for the following features when compared to ordinary infrared remote controls.

Operation Range: Area up to a 15 m

RF Technology

With ordinary remote controls, the operation range is limited because of directivity; they cannot operate if there are objects between the projector and the remote.

The GyroRemote can operate up to a range of 15 m (49.2 feet) by sending RF signals to the projector.

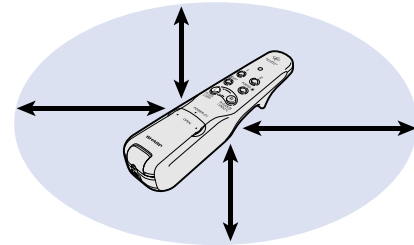

Note

- The control range measured is with the projector's antenna fully extended.
- The control range under actual operating conditions may be less than optimum depending on where the projector is placed.

Caution

Do not use the GyroRemote in restricted places, such as hospitals.

- Signals from the GyroRemote may affect electronic equipment or medical electronic equipment, thereby causing accidents.
- When using the GyroRemote in medical institutions, make sure to follow the directives of each institution.

Multi-Projector Control

This projector has a GyroRemote identification function that makes possible to perform various operations such as the ones below.

- No interference even if other projectors of the same type are within the GyroRemote's operating range.

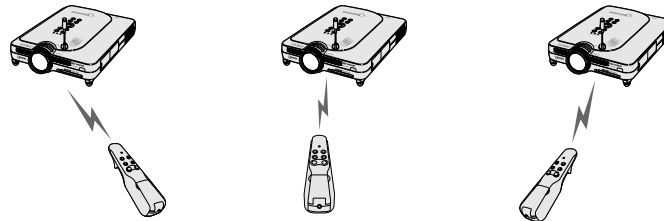

- Multiple projectors can be operated with one GyroRemote.

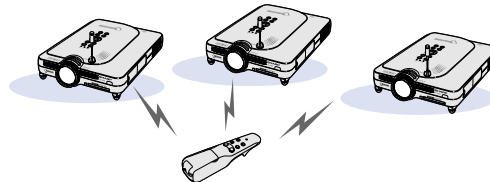

- One projector can be operated using multiple GyroRemotes.

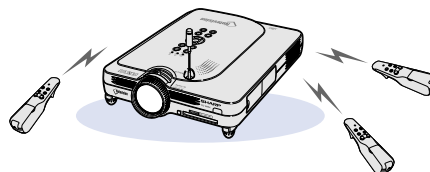

- Refer to page 40 for details about using the GyroRemote.



Calibrating the GyroRemote

If there are any extreme temperature changes when the GyroRemote is being used or after batteries have been replaced, the mouse cursor or pointer may continue to move by itself even if no action has been performed. In this case, calibrate the GyroRemote using the following procedure.

1 Double click  on the rear of the GyroRemote.

2 Make sure that the LED indicator is lit, and place the GyroRemote on a leveled location.

- After leaving the GyroRemote for 6 seconds, the calibration of the GyroRemote is complete.





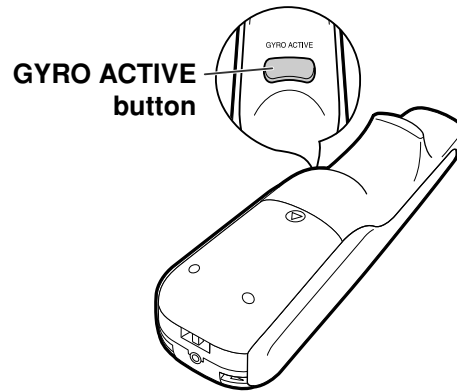

3 Press , after leaving the GyroRemote for more than 6 seconds.

- Calibration is complete after the remote has been left for more than 6 seconds.

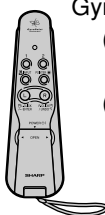
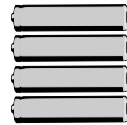
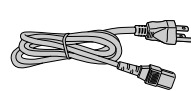
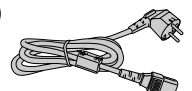
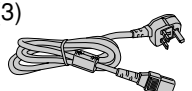
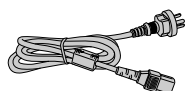

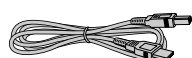
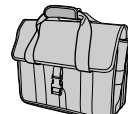
Accessories

Supplied accessories

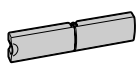
 <p>GyroRemote (1) For U.S., Canada, etc. RRMCG1631CESA (2) For Europe, Australia, Oceania and Asia RRMCG1653CESA</p>		 <p>Four R03 batteries ("AAA" size, UM/SUM-4, HP-16 or similar)</p>	
 <p>(1) Power cord (6' (1.8m)) For U.S., Canada, etc. QACDA007WJPZ</p>	 <p>(2) Power cord (6' (1.8m)) For Europe, except U.K. QACCV4002CEZZ</p>	 <p>(3) Power cord (6' (1.8m)) For U.K., Hong Kong and Singapore QACCB5024CENA</p>	 <p>(4) Power cord (6' (1.8m)) For Australia, New Zealand and Oceania QACCL3022CEZZ</p>
<p> Note</p> <ul style="list-style-type: none"> Depending on the region, projectors only ship with one power cord (see above). Use the power cord that corresponds to the wall outlet in your country. 			
 <p>DVI to 15-pin D-sub cable (6' (1.8m)) QCNWGA010WJZZ</p>	 <p>USB cable (6' (1.8 m)) QCNWG0001WJPZ</p>	 <p>Carrying case GCASN0005CESA</p>	 <p>Two Wireless LAN PC cards AN-WC11B (RUNTKA025WJZZ)</p>
 <p>Lens cap (attached) CCAPHA001WJ01</p>	 <p>Lens cap strap UBNDT0013CEZZ</p>	 <p>Terminal cover (attached) GCOVD0103CESA</p>	<p>CD-ROM UDSKA001WJZZ Operation manual (this manual) Quick reference guides Wireless Reality operation manual Wireless LAN PC card precautions</p>

Optional accessories

DVI cable (9'10" (3.0 m))	AN-C3DV
3 RCA to 15-pin D-sub cable (9'10" (3.0 m))	AN-C3CP
Computer RGB cable (32'10" (10.0 m))	AN-C10BM <for IBM-PC, PC9821, and PC98NX systems> AN-C10PC <for PC98 systems (Except PC9821 and PC98NX systems)>
5 BNC to 15-pin D-sub cable (9'10" (3.0 m))	AN-C3BN
RGB monitor loop-out adaptor (7.9" (20 cm))	AN-A1MY
DVI to 15-pin D-sub adaptor (7.9" (20 cm))	AN-A1DV
<ul style="list-style-type: none"> If you cannot connect after changing computer ports, be sure to check you computer's specifications. If you are still having difficulty connecting, a conversion connector (commercially available) may be necessary. 	
Wireless LAN PC card	AN-WC11B

 **Note** • All cables may not be available in all regions. Please check with your nearest Sharp Authorized Projector Dealer or Service Center.



Setup and Connections

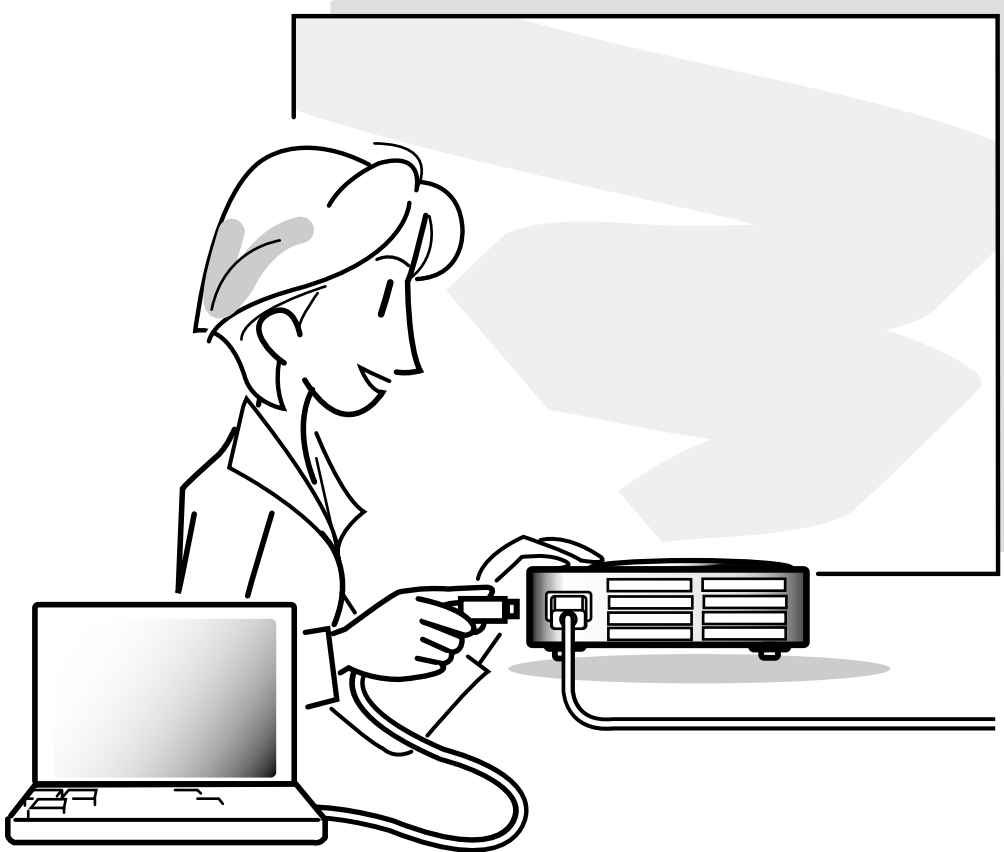

Setup and Connections



Setup

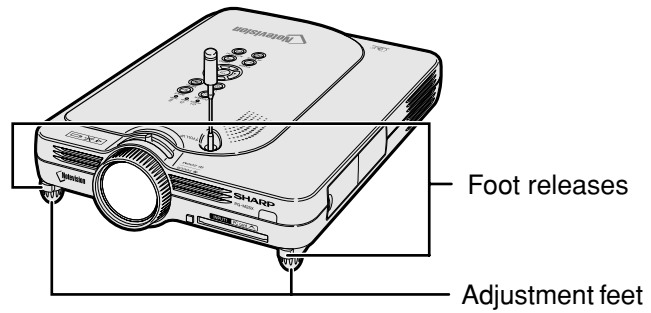

Using the Adjustment Feet

The height of the projector can be adjusted using the adjustment feet when the surface of the projector is placed on is uneven or when the screen is slanted.

The projection of the image can be made higher by adjusting the projector when it is in a location lower than the screen.

1 Press the foot releases.

2 Lift the projector to adjust its height and remove your hands from the foot releases.

3 Rotate the adjustment feet to make minor changes.

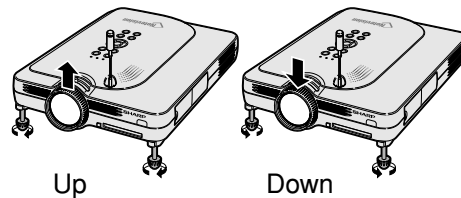
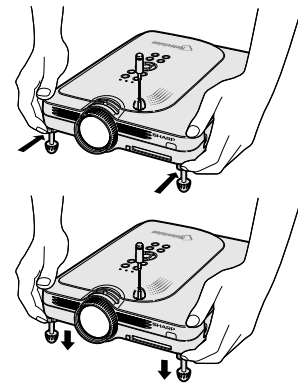

Note

- When returning the projector to its original position, hold the projector firmly, press the foot releases and then lower it.
- The projector is adjustable up to approximately 5.5 degrees from the standard position.

Info

- Do not press the foot releases when the feet are extended without firmly holding the projector.
- Do not hold the lens when lifting or lowering the projector.
- When lowering the projector, be careful not to get your fingers caught in the area between the adjustment feet and the projector.



Setting up the Screen

Position the projector perpendicular to the screen with all feet flat and level to achieve an optimal image.



Note

- The projector lens should be centered in the middle of the screen. If the horizontal line passing through the lens center is not perpendicular to the screen, the image will be distorted, making viewing difficult.
- For optimal image, position the screen so that it is not in direct sunlight or room light. Light falling directly on the screen washes out the colors, making viewing difficult. Close the curtains and dim the lights when setting up the screen in a sunny or bright room.
- A polarizing screen cannot be used with this projector.

Standard Setup (Front Projection)

- Place the projector at the required distance from the screen according to the desired picture size. (See page 24.)

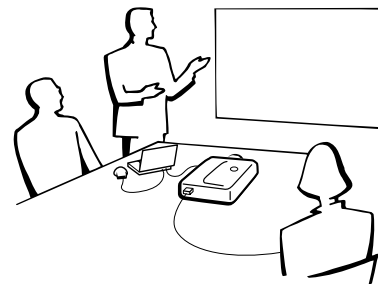

Example of Standard Setup

Side View

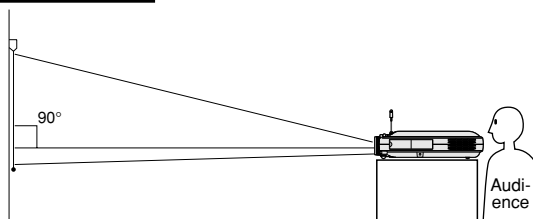

- The distance from the screen to the projector may vary depending on the size of the screen. **P.24**

- The default setting can be used, when placing the projector in front of the screen. If the projected image is reversed or inverted, readjust the setting to "Front" in "PRJ Mode". **P.98**

Top View

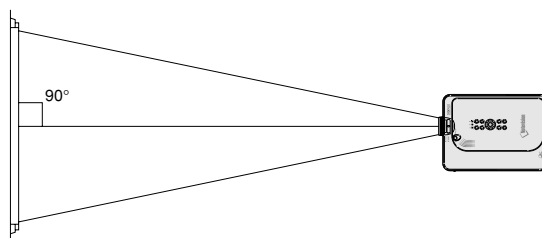

- Place the projector so that an imaginary horizontal line that passes through the center of the lens is perpendicular to the screen.



Setup (cont.)

Screen Size and Projection Distance

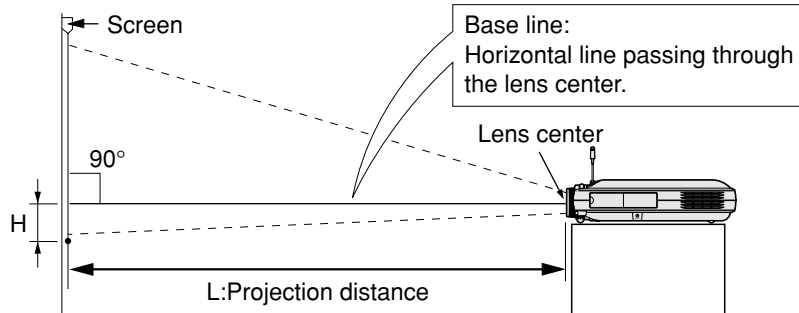

NORMAL Mode (4:3)

Picture (Screen) size			Projection distance (L)		Distance from the lens center to the bottom of the image (H)
Diag. (X)	Width	Height	Maximum (L1)	Minimum (L2)	
300" (762 cm)	240" (610 cm)	180" (457 cm)	—	39' 5" (12.0 m)	0" (0.0 cm)
250" (635 cm)	200" (508 cm)	150" (381 cm)	39' 8" (12.1 m)	32' 10" (10.0 m)	0" (0.0 cm)
200" (508 cm)	160" (406 cm)	120" (305 cm)	31' 9" (9.7 m)	26' 3" (8.0 m)	0" (0.0 cm)
150" (381 cm)	120" (305 cm)	90" (229 cm)	23' 9" (7.2 m)	19' 8" (6.0 m)	0" (0.0 cm)
100" (254 cm)	80" (203 cm)	60" (152 cm)	15' 10" (4.8 m)	13' 1" (4.0 m)	0" (0.0 cm)
84" (213 cm)	67" (170 cm)	50" (127 cm)	13' 3" (4.0 m)	10' 11" (3.3 m)	0" (0.0 cm)
72" (183 cm)	58" (147 cm)	43" (109 cm)	11' 4" (3.5 m)	9' 4" (2.9 m)	0" (0.0 cm)
60" (152 cm)	48" (122 cm)	36" (91 cm)	9' 5" (2.9 m)	7' 9" (2.4 m)	0" (0.0 cm)
40" (102 cm)	32" (81 cm)	24" (61 cm)	6' 3" (1.9 m)	5' 2" (1.6 m)	0" (0.0 cm)

The formula for picture size and projection distance

$$L1 \text{ (ft)} = (0.048539X - 0.037278) / 0.3048$$

$$L2 \text{ (ft)} = (0.040172X - 0.037561) / 0.3048$$

$$H \text{ (in)} = 0$$

X: Picture size (diag.) (in)
 L: Projection distance (m)
 L1: Maximum projection distance (ft)
 L2: Minimum projection distance (ft)
 H: Distance from the lens center to the bottom of the image (in)

STRETCH Mode (16:9)

Picture (Screen) size			Projection distance (L)		Distance from the lens center to the bottom of the image (H)
Diag. (X)	Width	Height	Maximum (L1)	Minimum (L2)	
250" (635 cm)	218" (554 cm)	123" (312 cm)	—	35' 9" (10.9 m)	-20 27 / 64" (-51.9 cm)
225" (572 cm)	196" (498 cm)	110" (279 cm)	38' 11" (11.9 m)	32' 2" (9.8 m)	-18 25 / 64" (-46.7 cm)
200" (508 cm)	174" (442 cm)	98" (249 cm)	34' 7" (10.5 m)	28' 7" (8.7 m)	-16 22 / 64" (-41.5 cm)
150" (381 cm)	131" (333 cm)	74" (188 cm)	25' 11" (7.9 m)	21' 5" (6.5 m)	-12 16 / 64" (-31.1 cm)
133" (338 cm)	116" (295 cm)	65" (165 cm)	22' 11" (7.0 m)	18' 12" (5.8 m)	-10 56 / 64" (-27.6 cm)
106" (269 cm)	92" (234 cm)	52" (132 cm)	18' 3" (5.6 m)	15' 1" (4.6 m)	-8 42 / 64" (-22.0 cm)
100" (254 cm)	87" (221 cm)	49" (124 cm)	17' 3" (5.3 m)	14' 3" (4.3 m)	-8 11 / 64" (-20.8 cm)
92" (234 cm)	80" (203 cm)	45" (114 cm)	15' 10" (4.8 m)	13' 1" (4.0 m)	-7 33 / 64" (-19.1 cm)
84" (213 cm)	73" (185 cm)	41" (104 cm)	14' 5" (4.4 m)	11' 11" (3.6 m)	-6 55 / 64" (-17.4 cm)
72" (183 cm)	63" (160 cm)	35" (89 cm)	12' 4" (3.8 m)	10' 3" (3.1 m)	-5 57 / 64" (-14.9 cm)
60" (152 cm)	52" (132 cm)	29" (74 cm)	10' 3" (3.1 m)	8' 6" (2.6 m)	-4 58 / 64" (-12.5 cm)
40" (102 cm)	35" (89 cm)	20" (51 cm)	6' 10" (2.1 m)	5' 7" (1.7 m)	-3 17 / 64" (-8.3 cm)

The formula for picture size and projection distance

$$L1 \text{ (ft)} = (0.052882X - 0.037278) / 0.3048$$

$$L2 \text{ (ft)} = (0.043766X - 0.037561) / 0.3048$$

$$H \text{ (in)} = -0.08171X$$

BORDER Mode (4:3)

Picture (Screen) size			Projection distance (L)		Distance from the lens center to the bottom of the image (H)
Diag. (X)	Width	Height	Maximum (L1)	Minimum (L2)	
200" (508 cm)	160" (406 cm)	120" (305 cm)	—	35' 0" (10.7 m)	-20" (-50.8 cm)
180" (457 cm)	144" (366 cm)	108" (274 cm)	38' 1" (11.6 m)	31' 6" (9.6 m)	-18" (-45.7 cm)
150" (381 cm)	120" (305 cm)	90" (229 cm)	31' 9" (9.7 m)	26' 3" (8.0 m)	-15" (-38.1 cm)
100" (254 cm)	80" (203 cm)	60" (152 cm)	21' 1" (6.4 m)	17' 5" (5.3 m)	-10" (-25.4 cm)
84" (213 cm)	67" (170 cm)	50" (127 cm)	17' 9" (5.4 m)	14' 8" (4.5 m)	-8 26 / 64" (-21.3 cm)
72" (183 cm)	58" (147 cm)	43" (109 cm)	15' 2" (4.6 m)	12' 6" (3.8 m)	-7 13 / 64" (-18.3 cm)
60" (152 cm)	48" (122 cm)	36" (91 cm)	12' 7" (3.8 m)	10' 5" (3.2 m)	-6" (-15.2 cm)
40" (102 cm)	32" (81 cm)	24" (61 cm)	8' 4" (2.6 m)	6' 11" (2.1 m)	-4" (-10.2 cm)

The formula for picture size and projection distance

$$L1 \text{ (ft)} = (0.064719X - 0.037278) / 0.3048$$

$$L2 \text{ (ft)} = (0.053563X - 0.037561) / 0.3048$$

$$H \text{ (in)} = 0.100X$$

Note

- There is an error of ± 3% in the formula above.
- Values with a minus (-) sign indicate the distance of the lens center below the bottom of the image.





Projecting a Reversed/Inverted Image

Projection from behind the screen

- Place a translucent screen between the projector and the audience.
- Reverse the image by setting “Rear” in “PRJ Mode”. See page 98 for use of this function.

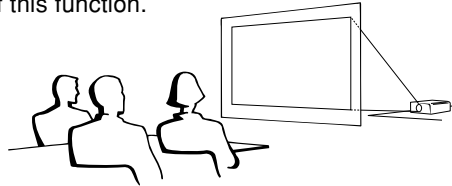

Projection using a mirror

- Place a mirror (normal flat type) in front of the lens.
- Reverse the image by setting “Rear” in “PRJ Mode”, when the mirror is placed on the audience side. See page 98 for use of this function.

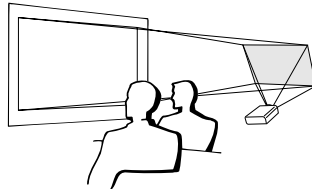

Info

- When using a mirror, be sure to carefully position both the projector and the mirror so the light does not shine into the eyes of the audience.

Ceiling-mount setup

- It is recommended that you use the optional Sharp ceiling-mount bracket for this installation. Before mounting the projector, contact your nearest Sharp Authorized Projector Dealer or Service Center to obtain the recommended ceiling-mount bracket (sold separately.) (AN-PGCM90 ceiling-mount bracket, its AN-EP101B extension tube and AN-JT200 universal bracket, adaptor for non-level ceiling installation (for U.S.A.), BB-M20T ceiling adaptor, its BB-NVHOLDER280, BB-NVHOLDER550, BB-NVHOLDER900 ceiling mount systems (for GERMANY), or AN-60KT ceiling-mount bracket, its AN-TK301/AN-TK201 and AN-TK302/AN-TK202 extension tubes (for countries other than the U.S.A. and GERMANY))

- Be sure to adjust the position of the projector to match the distance (H) from the lens center position (see page 24) to the lower edge of the image, when mounting the projector on the ceiling.
- Invert the image by setting “Ceiling + Front” in “PRJ Mode”.

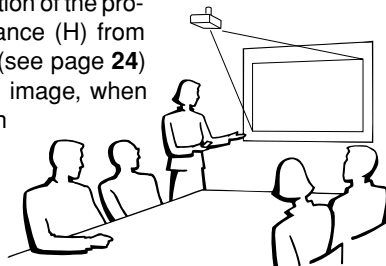

When using the default setting.
▼On-screen Display

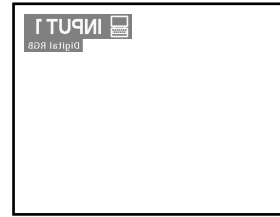

The image is reversed.

When using the default setting.
▼On-screen Display

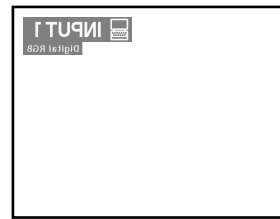

The image is reversed.

When using the default setting.
▼On-screen Display



The image is inverted.



Connecting the Projector to Other Devices

Before Connecting



Note

- Before connecting, be sure to turn off both the projector and the devices to be connected. After making all connections, turn on the projector and then the other devices.
When connecting a computer, be sure that the computer is the last device to be turned on after all the connections are made.
- Be sure to read the operation manuals of the devices to be connected before making connections.

This projector can be connected to:

A computer using:

- A DVI to 15-pin D-sub cable (See page 27.)
- A DVI cable (type AN-C3DV) (sold separately) (See page 28.)
- A wireless LAN PC card (See page 31.)

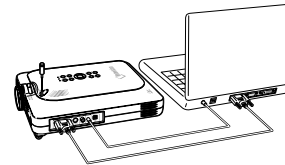

Component video or audio-visual equipment:

- A DVD player or DTV* decoder (See page 29.)
- A VCR, Laser disc player or other audio-visual equipment (See page 30.)

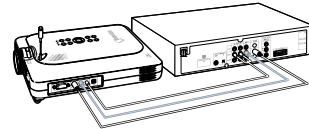
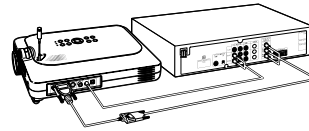

*DTV is the umbrella term used to describe the new digital television system in the United States.

A monitor using:

- An RGB monitor loop-out adaptor (AN-A1MY) (sold separately) and an RGB cable (commercially available). (See page 32.)

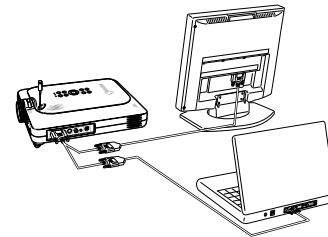

Connecting the Power Cord

- 1 Plug in the supplied power cord into the AC socket on the rear of the projector.

GB-26

Supplied accessory

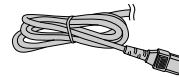

Power cord

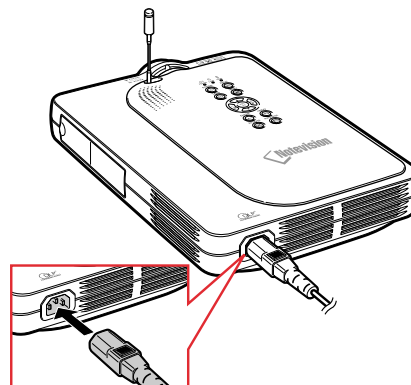



Connecting the Projector to a Computer

Connecting to a Computer Using the DVI to 15-pin D-sub Cable

1 Connect the projector to the computer using the supplied DVI to 15-pin D-sub cable.

- Secure the connectors by tightening the thumbscrews.

2 To input audio signal, connect the projector to the computer using a $\varnothing 3.5$ mm stereo audio cable (commercially available or available as Sharp service part QCNW-4870CEZZ).

Note

- See page 115 “Computer Compatibility Chart” for a list of computer signals compatible with the projector. Use with computer signals other than those listed may cause some of the functions not to work.
- When connecting the projector to a computer in this way, select “RGB” for “Signal Type” in the “Picture” menu. See page 60.
- A Macintosh adaptor may be required for use with some Macintosh computers. Contact your nearest Sharp Authorized Projector Dealer or Service Center.

Supplied accessory

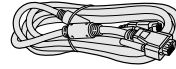

DVI to 15-pin D-sub cable

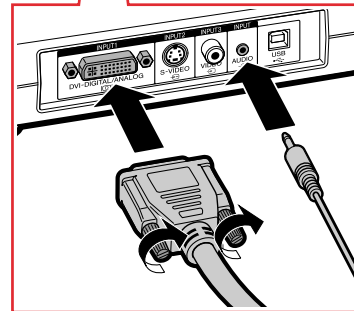
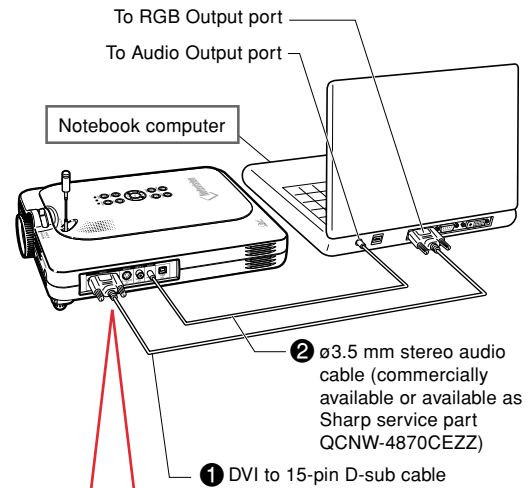

Connecting the thumbscrew cables

- Connect the thumbscrew cable making sure that it fits correctly into the port. Then, firmly secure the connectors by tightening the screws on both sides of the plug.
- Do not remove the ferrite core attached to the DVI to 15-pin D-sub cable.

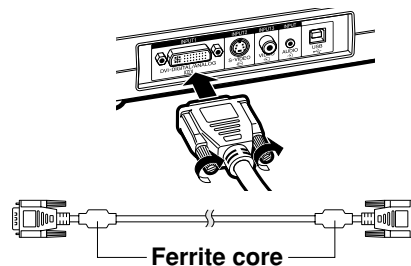

Connecting the Projector to Other Devices (cont.)

Connecting to a Computer Using a DVI Cable (Sold Separately)

This projector comes installed with a DVI digital input terminal in which computer digital image signals can be directly input.

1 Connect the projector to the computer using the DVI cable.

2 To input audio signal, connect the projector to the computer using a $\varnothing 3.5$ mm stereo audio cable (commercially available or available as Sharp service part QCNW-4870CEZZ).

Note

- This DVI port is DVI version 1.0 compatible. Therefore when the signal is input from copy guard system compatible (DVI version 2.0) equipment, no signal will be received.

Optional accessory

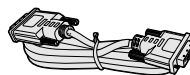

DVI cable
Type: AN-C3DV
(9'10" (3.0 m))

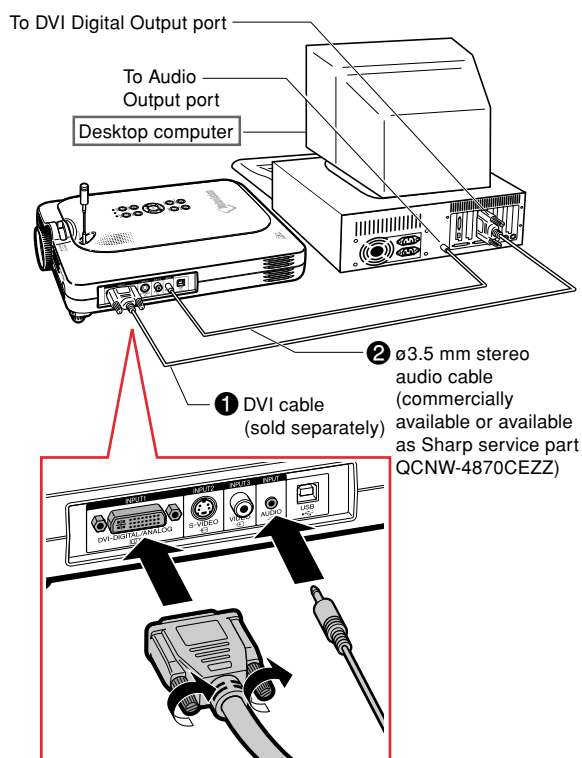

“Plug and Play” function (when connecting to a 15-pin terminal)

- This projector is compatible with VESA-standard DDC 1/DDC 2B. The projector and a VESA DDC compatible computer will communicate their setting requirements, allowing for quick and easy setup.
- Before using the “Plug and Play” function, be sure to turn on the projector first and the connected computer last.

Note

- The DDC “Plug and Play” function of this projector operates only when used in conjunction with a VESA DDC compatible computer.



Connecting to Video Equipment

Connecting to Component Video Equipment

Use a 3 RCA to 15-pin D-sub cable and DVI to 15-pin D-sub adaptor when connecting to the INPUT 1 terminal, component video equipment such as DVD players and DTV* decoders.

*DTV is the umbrella term used to describe the new digital television system in the United States.

1 Connect the 3 RCA to 15-pin D-sub cable using the DVI to 15-pin D-sub adaptor.

2 Use the above cables to connect the projector and the video equipment.

3 Connect the projector and the video equipment using a $\varnothing 3.5$ mm to RCA audio cable (commercially available).

Note

- When connecting the projector to the video equipment in this way, select "Component" for "Signal Type" in the "Picture" menu. See page 60.
- A $\varnothing 3.5$ mm stereo minijack to RCA audio cable (commercially available) is required for audio input.

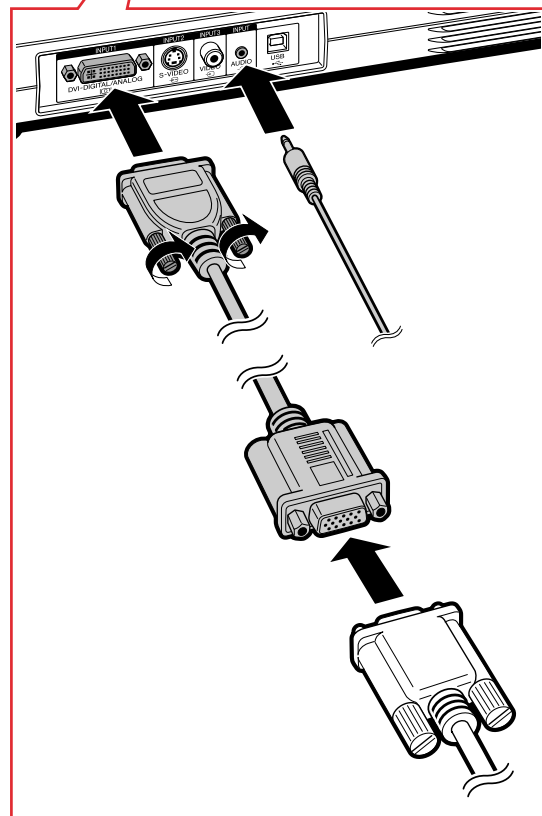
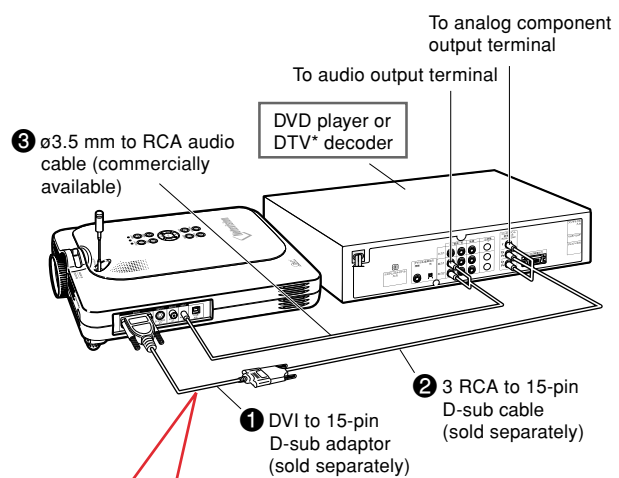
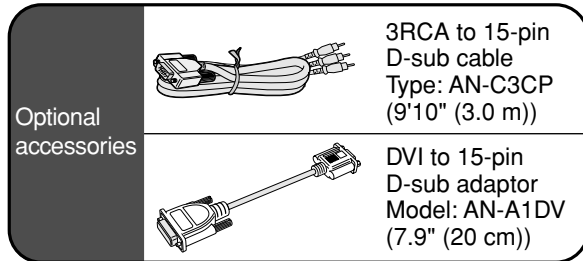



Connecting the Projector to Other Devices (cont.)

Connecting to Video Equipment Using an S-VIDEO, a Composite Video or an Audio Cable

Using an S-VIDEO, video, or audio cable, a VCR, laser disc player or other audio-visual equipment can be connected to INPUT 2, INPUT 3 and AUDIO terminals.

- 1** Connect the projector to the video equipment using a $\varnothing 3,5$ mm to RCA S-VIDEO cable or a composite video cable (both commercially available).
- 2** Connect the projector to the video equipment using a $\varnothing 3,5$ mm to RCA audio cable (commercially available).

Note

- The S-VIDEO INPUT terminal uses a video signal system in which the picture is separated into color and luminance signals to realize a higher-quality image. For realizing a higher-quality image, use a commercially available S-VIDEO cable to connect the S-VIDEO terminal on the projector and the S-VIDEO output terminal on the video equipment.
- A $\varnothing 3,5$ mm minijack to RCA audio cable (commercially available) is required for audio input.

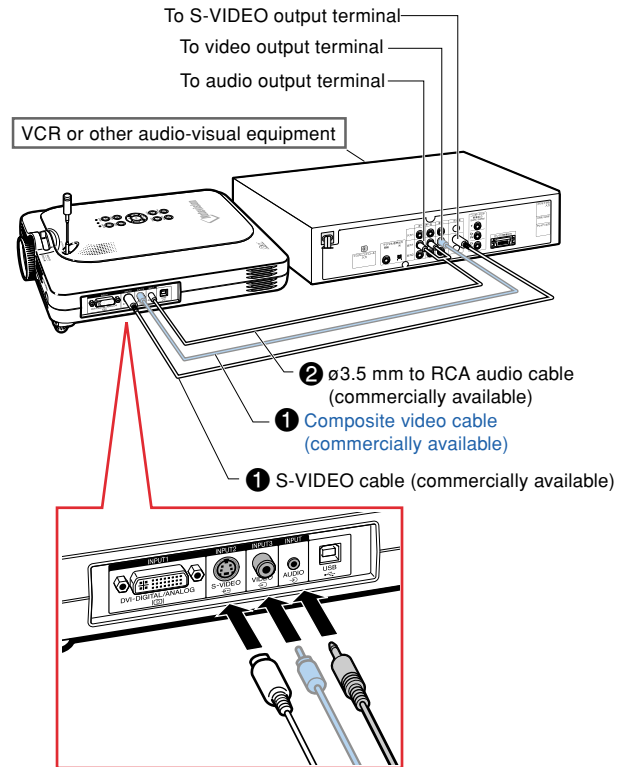



Installing / Removing the PC Card

Installing the PC Card in to INPUT 4 Terminal

Insert a PC card such as a wireless LAN card or memory card as shown on the right.

Info

- We recommend that you recess the Eject button before inserting the PC card. This will prevent accidental ejection during operation.
- The input mode will change automatically to INPUT 4, when the PC card has been inserted into INPUT 4 terminal.

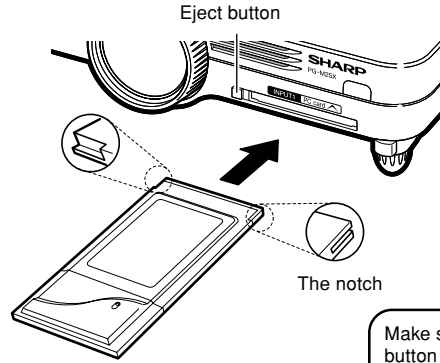

Make sure that the Eject button is not out, and that the notch on the card is to the left, when installing the card.
Take care when installing the card, as it has both a top part and an under part.

Removing the PC Card

1 In the Card menu, select “Eject PC Card”. For details see page 68.

2 Remove the card.

Note

- To prevent unstable operation, it is recommended that you use the EJECT PC CARD function in PC CARD menu before removing the PC card.

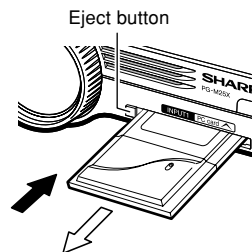
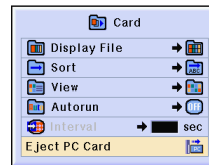

1 Press the Eject button. The Eject button pops out.

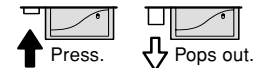

2 Press the Eject button again. The PC Card will protrude from the card slot on the computer.

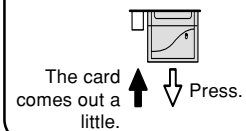

Remove the card from the slot and store it in a safe place. If the Eject button is out, press it once more to set it back in place.



Connecting the Projector to Other Devices (cont.)

Connecting to a Monitor

Watching Images on Both the Projector and a Monitor

You can display computer images on both the projector and a separate monitor using an RGB monitor loop-out adaptor and an RGB cable.

1 Connect the projector to the computer and monitor using an RGB monitor loop-out adaptor (sold separately) and an RGB cable (commercially available).

2 In the “Options(1)” menu, select “Monitor Out” and then “Yes (Y cable)”.

- If “Disable” is selected, the projected image will be dimmer. This does not indicate a malfunction. For details, see page 96.

Note

- When using an RGB monitor loop-out adaptor (sold separately), make sure that the cable is connected to the monitor.
- Analog RGB signals as well as Component signals can be output to the monitor.

Info

- Only analog RGB/Component signals entered into the DVI port can be output. Signals from equipment connected to the DVI digital port cannot be output.

Using INPUT 1 Terminal with the Terminal Cover Attached to the Projector

The INPUT 1 terminal can be used with the terminal cover folded as shown in the illustration.

GB-32

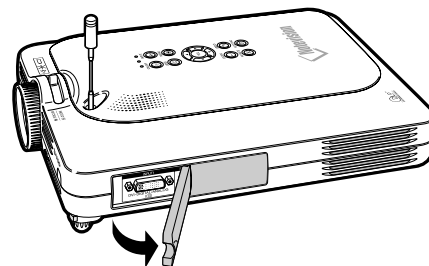
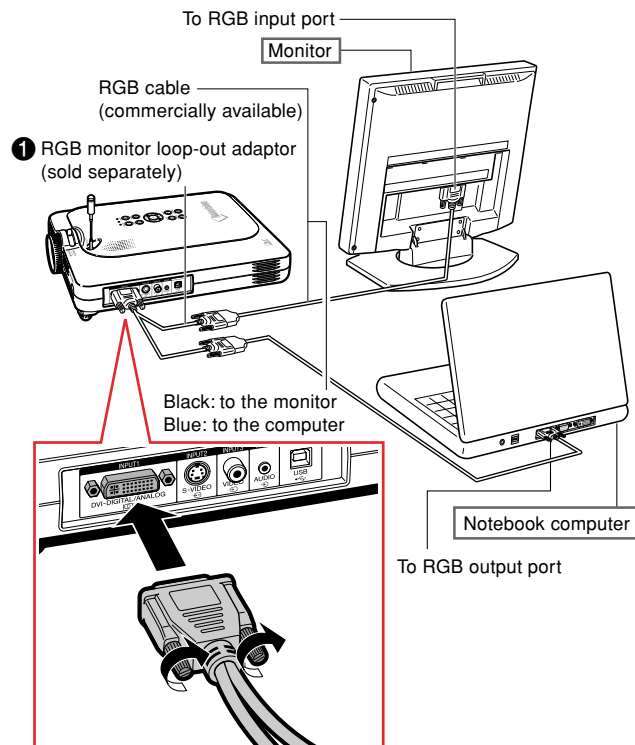
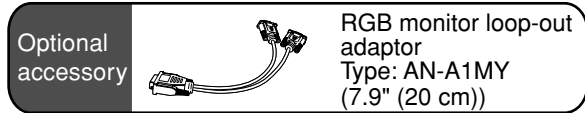



Basic Operation

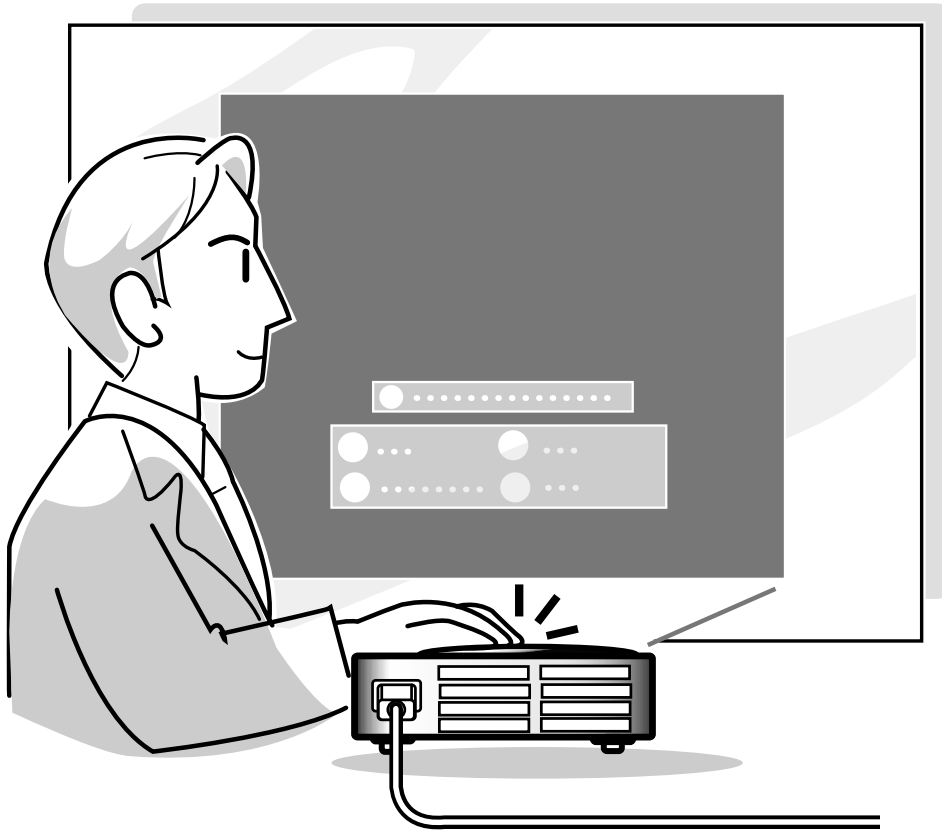

Basic Operation

Image Projection

Basic Procedure

Connect the required external equipment to the projector before operating the following procedures. Details are found in the projector operation manual.

Info

- The language preset at the factory is English. If you want to change the on-screen display to another language, reset the language according to the procedure on page 37.

1 Plug the power cord into the wall outlet.

- The POWER indicator illuminates up in red, and the projector enters standby mode.

2 Press on the projector or on the GyroRemote.

- The POWER indicator illuminates in green. After the LAMP REPLACEMENT indicator illuminates, the projector is ready to start operation.

Note

- The LAMP REPLACEMENT indicator illuminates, indicating the status of the lamp.

Green: The lamp is ready.

Green blinking: The lamp is warming up.

Red: The lamp should be replaced.

- If the power is turned off and immediately switched on again, the LAMP REPLACEMENT indicator may take time to illuminate.

When "Anti-Theft" (see page 102) is set, the keycode input box will appear.

- Enter the keycode.

Note

- When entering the keycode, press the buttons previously set on the projector or the GyroRemote.

Info

- When "Anti-Theft" is set, enter the keycode or the input display will not appear. Even when the signal is input, the display will not appear. (See page 102.)

▼Projector indicators

LAMP REPLACEMENT indicator
POWER indicator

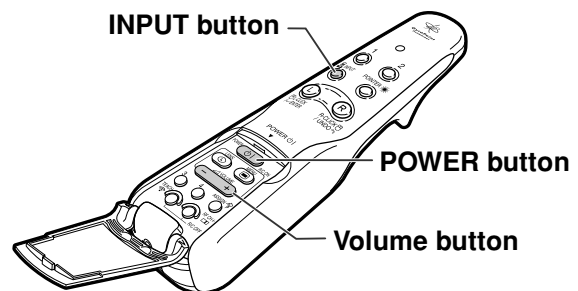
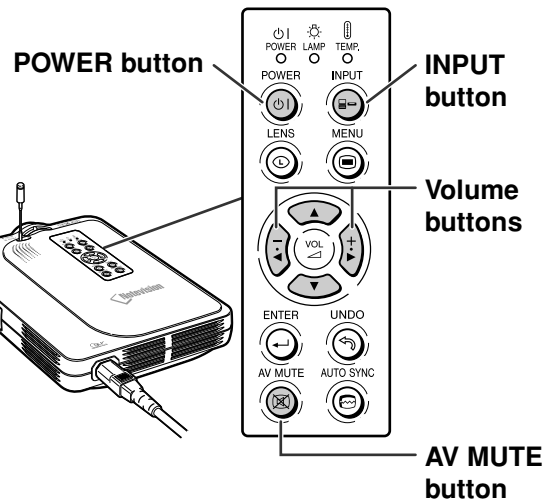
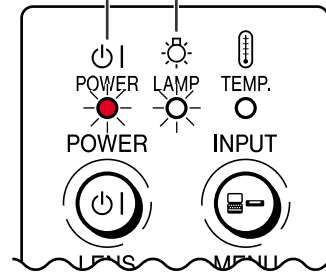

▼Keycode input box



4 Press and select the input mode.

- Each press switches in the following order*

→ INPUT 1 → INPUT 2 → INPUT 3 → INPUT 4

- You can also use the  on the GyroRemote.

Note









- When no signal is received, “NO SIGNAL” will be displayed. When a signal that the projector is not preset to receive is received, “NOT REG.” will be displayed.
- When Auto Search is ON, the input modes with signals can be selected (See page 91.)
- When a PC card is inserted, the input will automatically change to INPUT 4.
- You can select the input mode directly by using the Button Assign function on the GyroRemote (See page 41.)

About the INPUT Modes

INPUT 1 (RGB/Component)	Used for projecting images from equipment that sends RGB signals or Component signals connected to the DVI-DIGITAL/ANALOG input port.
INPUT 2 (S-Video)	Used for projecting images from equipment connected to the S-VIDEO input terminal.
INPUT 3 (Video)	Used for projecting images from equipment connected to the VIDEO input terminal.
INPUT 4 (PC Card)	When projecting from a wireless LAN PC card or a memory card.

5 Press or on the GyroRemote to adjust the volume.

Note

- Pressing  will raise the volume.
Pressing  will lower the volume.
- On the GyroRemote, the volume can be adjusted by pressing .
- When a PC card is installed, ,  on the projector or  on the GyroRemote operate as cursor buttons (, ) when the OSD menu is active.

▼ On-screen Display (Example)

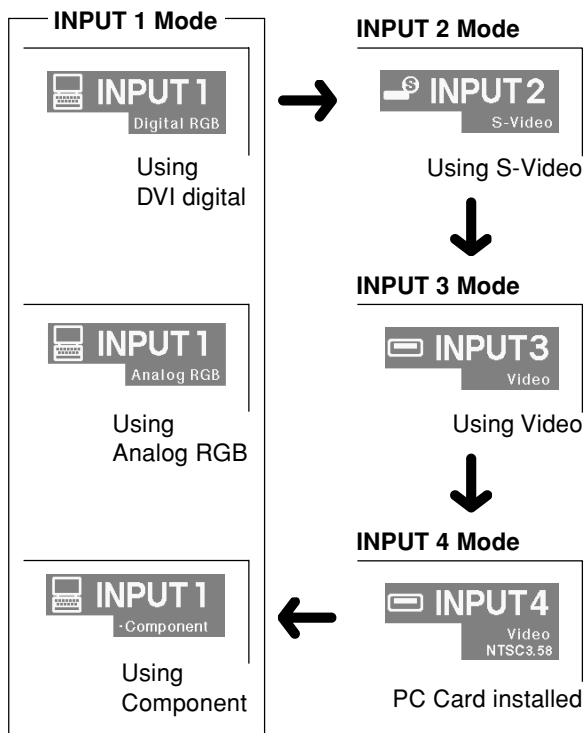









Image Projection (cont.)

6 Press  on the projector to temporarily turn off the picture and sound.

 **Note**

- Pressing  again will turn the picture and the sound back on.
- When using the GyroRemote, you can select AV MUTE using the Button Assign function (see page 41.)
- If you want to temporarily mute the sound, select MUTE using the Button Assign function (see page 41.)

 AV MUTE

7 Press  on the projector or  on the GyroRemote. When the confirmation screen is displayed, press  or  once again.

 **Note**

- If you accidentally pressed  and do not want to turn off the power, wait until the confirmation message disappears.

 **Info**

- Do not unplug the power cord during projection or cooling fan operation. This can cause damage due to the rise in internal temperature, as the cooling fan also stops.
- When connected to equipment such as an amplifier, be sure to turn off the power to the equipment connected first and then to the projector.



 Turn Power OFF?
Yes: Press Again No: Please Wait



Selecting the On-screen Display Language

- The on-screen display language of the projector can be set to English, German, Spanish, Dutch, French, Italian, Swedish, Portuguese, Chinese, Korean or Japanese.
- The following explanation uses operations from the projector as example.

1 Press .

- The menu will be displayed.

2 Press  or  to select "Language".

3 Press  or  to select the desired language, and then press .

4 Press .

- The desired language will be set as the on-screen display.

Adjusting the Lens

The image is focused and adjusted to the desired size using the focus ring or zoom knob on the projector.

1 The focus is adjusted by rotating the focus ring.

2 Zooming is adjusted by moving the zoom knob.

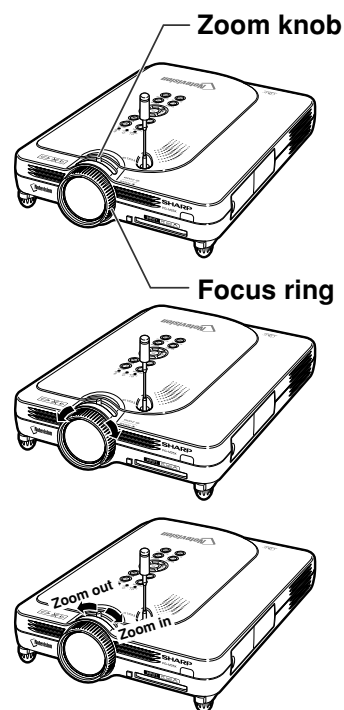
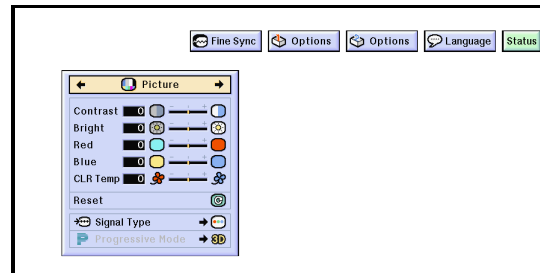



Correcting the Trapezoidal Distortion (Keystone Correction)

Correcting the Trapezoidal Distortion

This function allows for Keystone (On-screen Trapezoidal Distortion) Correction. The following explanation uses operations from the projector as example.

Note

- Keystone Correction is the correction for trapezoidal distortion that occurs when the image is positioned away from the center axis of the screen.
- The trapezoidal distortion can be corrected up to an angle of approximately ± 35 degrees.
- The projector can be adjusted to a maximum of 10 degrees.

1

Press



- Pressing again while the BORDER, STRETCH or SMART STRETCH screen is displayed will start the Digital Shift function. See page 39.
- You can also use on the GyroRemote.

2

Press or to adjust the Keystone correction.

- If you want to make more detailed corrections, press to display the test pattern, and then press or to make the adjustments.
- Adjustments can also be done using the or button on the GyroRemote.

Note

- Since the trapezoidal distortion of the image can be corrected up to an angle of approximately ± 35 degrees, the actual screen can be diagonally set up to that angle as well.
- Press to cancel Keystone Correction.
- You can delete using the button on the GyroRemote.

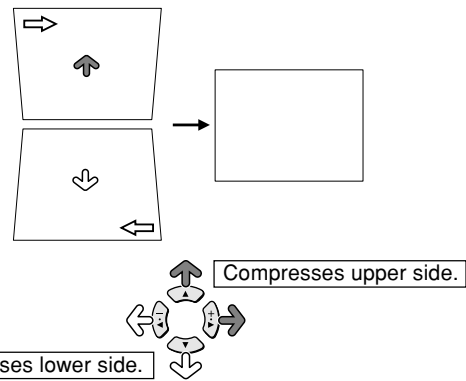
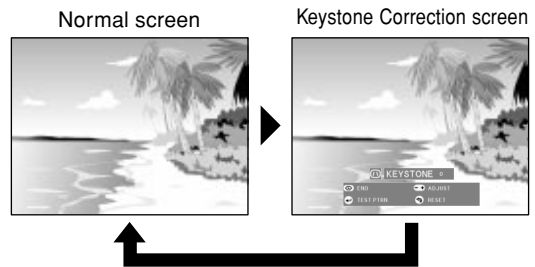
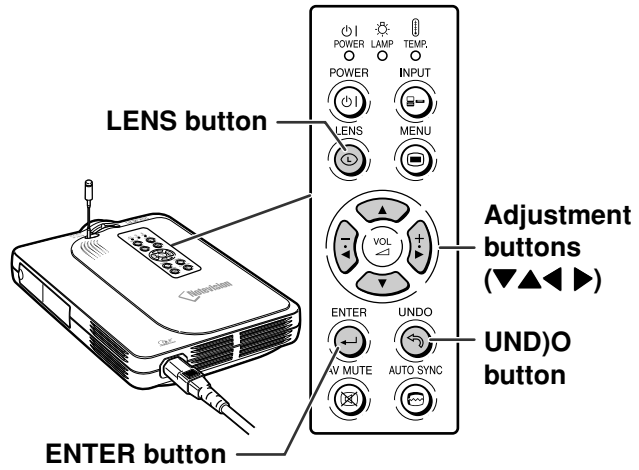



3 Press .

Note

- You can use the same settings used in NORMAL mode 4:3 for 16:9.
- Straight lines or the edges of images may appear jagged while adjusting the image.
- The Digital Shift function is displayed when a wide screen from video or digital video is displayed.

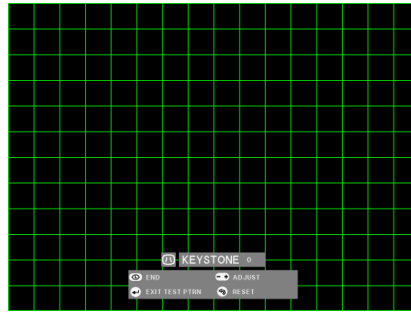

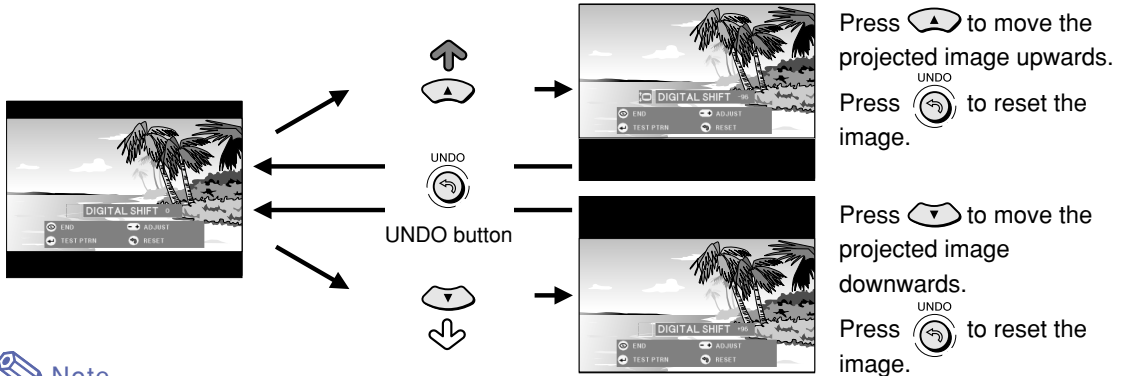

Digital Shift Setting

For easier viewing, this function shifts the image projected on the screen up or down eliminating either the upper or lower black band found in 16:9 and other wide aspect ratios.



Note

When using the GyroRemote:

- You can use the  button to move the screen up or down.
- Press  to return to the original position.
- The Digital Shift function works with STRETCH or SMART STRETCH screen. For details, see page 83.



Using the GyroRemote

Before Using the GyroRemote

Make sure that the antenna on the projector is fully extended before operating the projector with the GyroRemote.

Info

- The control range under actual operating conditions may be less than optimum depending on where the projector is placed and the radio signal environment.
- If the GyroRemote does not operate, press  on the GyroRemote.

Gesture Operation (Selecting OSD Menus, Operating Presentation Tools)

The GyroRemote accurately tracks your hand movements in the air while holding it and performs the following operations.

- **Bright and easy-to-see screen pointer.** (See page 44.)
- **Operate the menu with a simple wave of the hand.** (See pages 54, 55.)
- **Press ASSIGN to toggle and display the 5 "Button ASSIGN" lists one-by-one.** Each "Button ASSIGN" list has 4 selection items. (See page 41.)
- **With the GyroRemote you can operate your computer with the same feeling as operating a normal mouse by connecting the projector and a computer using the included USB cable.** (See page 47.)

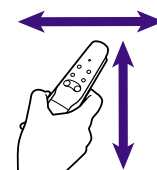
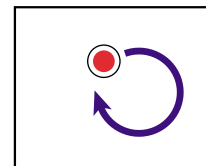
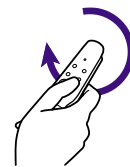
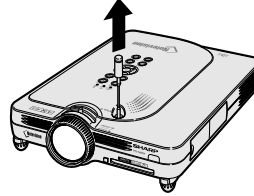

Function 1 button Function 2 button

Function 3 button ASSIGN button

Function 4 button

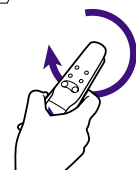

Mouse Control

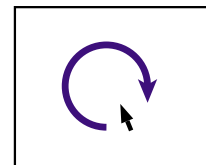



Function Assign

The Button Assign function on the GyroRemote, consists of 5 items (1/5 to 5/5) and within each, there are 4 function buttons (Function 1 to 4.)

Selecting the function buttons for assigning items is done via the projector.

1 Press on the GyroRemote.

- Each time you press  the Button Assign selection changes as shown below.

→ 1/5 → 2/5 → 3/5 → 4/5 → 5/5 →

2 Press The Button Assign selection display disappears.

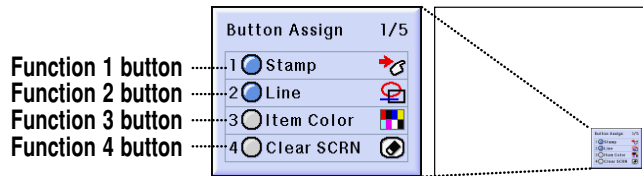
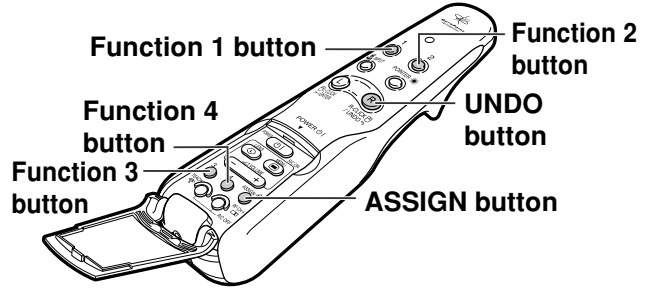

All Button Assign selections

- The list can also be displayed using 

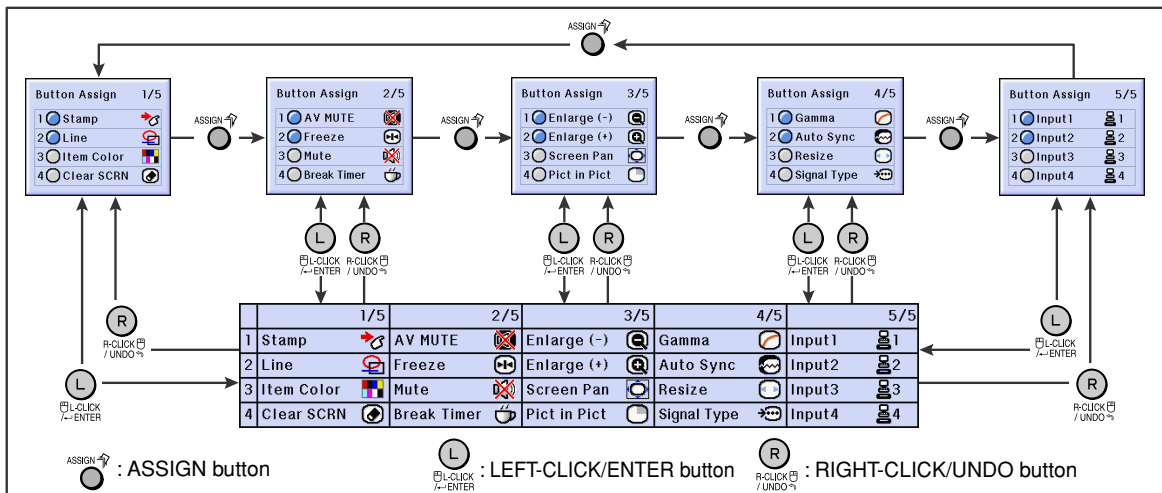



Using the GyroRemote (cont.)

GyroRemote Channel Setting

The GyroRemote uses radio signals, which can receive interference under certain conditions. To avoid interference, when using multiple GyroRemotes, register a different channel for each GyroRemote in the projector. The GyroRemote has 8 channels for U.S., Canada, etc. and 4 channels for Europe, Australia, Oceania and Aisa.

1 Press  located on the GyroRemote.

- You can also confirm the RF channel by the number of times the LED indicator flashes.
(Ex: RF Channel 3 if the LED indicator flashes 3 times.)

2 Hold  for more than 1 sec.

- Each time you press for over 1 sec. the RF channel changes as shown below.

For U.S., Canada, etc.

→ 1 → 2 → 3 → 4 → 5 → 6 → 7 → 8

For Europe, Australia, Oceania and Asia

→ 1 → 2 → 3 → 4

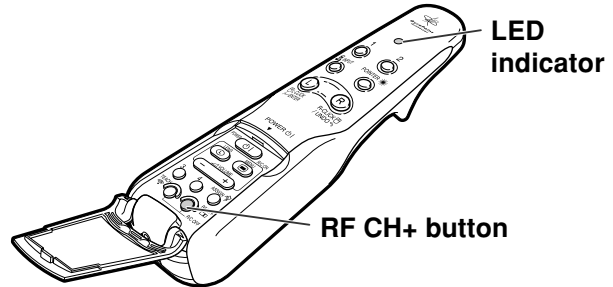



RF CH : 3

Registering the GyroRemote in the Projector

When using one GyroRemote with multiple projectors or one projector with multiple GyroRemotes, the GyroRemote(s) should be stored in the projector.

1 Select "Register R/C" in the Option (1) menu.

2 On the "Do you want to enter the Learn MOde?" (If the Gyro is connected to projector by cable, temporarily unplug the cable from the projector and press ENTER button.) message, select "Yes" using  or , and press .

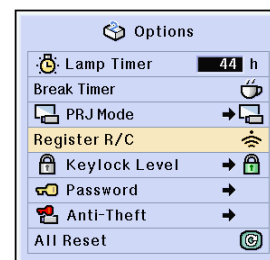
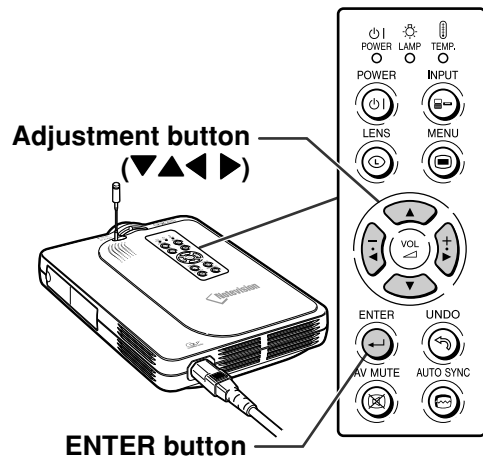

3 Press on the GyroRemote you want to register.

- The LED indicator on the GyroRemote lights up.
- “Register” is displayed at the bottom of the screen for a few seconds and registration starts. When storing is complete, “Learn Mode” is displayed.

Note

- If no action is taken for more than 5 minutes, the projector exits from the Learn mode.

4 Press

- This completes the Registration mode.

Registering Multiple GyroRemotes in One Projector

A maximum of 8 GyroRemotes for U.S., Canada, etc. and 4 for Europe, Australia, Oceania and Asia can be registered.

1 Set the same channel for the RF channel of the GyroRemote you want to register.

2 Using step 2 in page 42, press on the GyroRemotes to be used.

- When registering other GyroRemotes continuously, after each GyroRemote is registered and the Registration mode message is displayed, proceed with the next GyroRemote.
- After 8 GyroRemotes for U.S., Canada and 4 for Europe, Australia, Oceania and Asia have been registered, the Registration mode will automatically terminate.

3 Press when the number of registered GyroRemotes is fewer than 8 for U.S., Canada and 4 for Europe, Australia, Oceania and Asia.

- This ends the Registration mode.

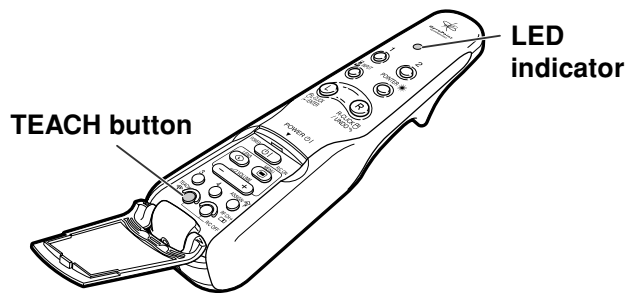

Register

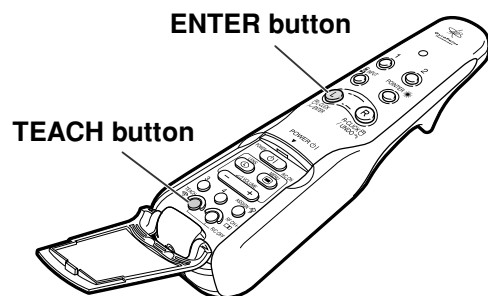

Register: Press TEACH on RC

Exit: Press ENTER



Using the Presentation Tools

The GyroRemote is equipped with the following presentation tools. These are very useful when emphasizing a main point during the presentation.

- Pointer function
- Stamp function
- Line function

Using the Pointer

Using the GyroRemote. For details see page 40.

1 Hold the GyroRemote and move it while pressing .

- The pointer moves in accordance with the GyroRemote's movements.
- The pointer disappears when  is released.

Note

- When operating the GyroRemote with multiple projectors, the position of the pointer may be slightly off in each projector. This does not indicate a malfunction.

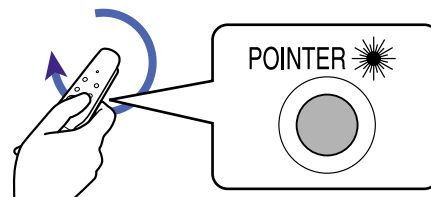
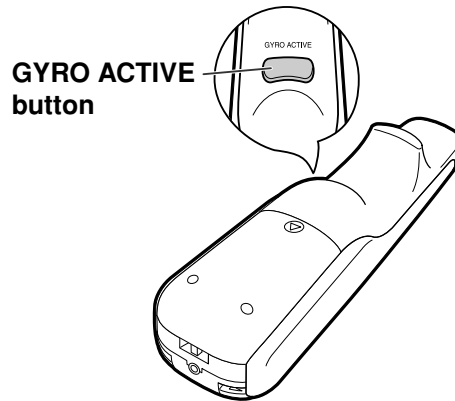
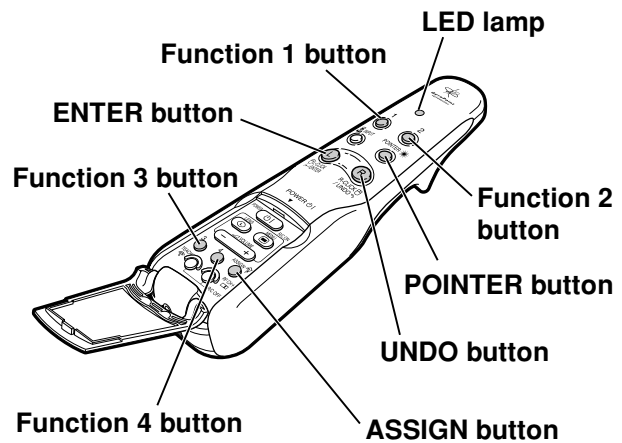





Using the Stamp Function

Using the GyroRemote
For details see page 40.

1 Press  on the GyroRemote and then select “Button Assign 1/5”.

- The assign function is displayed at the bottom right of the screen.

2 Press  on the GyroRemote.

- The stamp type will change every time  is pressed, as shown on the right.

3 Press  on the GyroRemote to select the color.

- The stamp color will change every time  is pressed, as shown on the right.



4 Move the GyroRemote while holding down .

- The stamp will move on the screen.

5 Release  at the location on the screen that you want to stamp, and press .

- The stamp will be fixed at that location.

Note

- If you want to display another stamp, repeat steps 2 to 4.
- Press  to clear a stamp.
- Even if the GyroRemote is moved,  will not function if it is not held down.

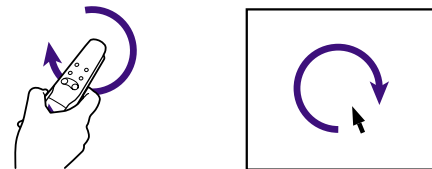
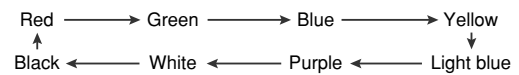
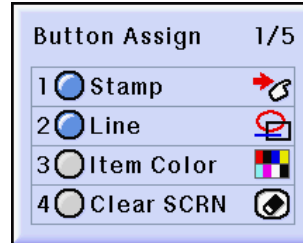



Using the Presentation Tools (cont.)



Using the Line Function

Using the GyroRemote, you can draw on the screen various shapes such as squares, ovals, horizontal, vertical, perpendicular and free-style lines.

Using the GyroRemote,
For details see page 40.



1 Press  on the GyroRemote and then select "Button Assign 1/5".
• The assign function is displayed at the bottom right of the screen.

2 Press  on the GyroRemote.
• The type of drawing will change every time  is pressed, as shown on the right.



3 Press  on the GyroRemote to select the color.
• The Line color will change every time  is pressed, as shown on the right.

4 Move the cursor to the starting position while holding down  on the GyroRemote.



Note









- If you want to display another stamp, repeat steps 2 to 4.
- Press  to delete a stamp just inserted.
- Press  to clear all stamps.

5 Release  on the GyroRemote and press .

6 Move the cursor to the ending position while holding down  on the GyroRemote, and press .

Note

- If you want to draw another shape or line, repeat steps 1 to 5.
- Press  to clear any shapes or lines you have just drawn in.
- Press  to clear all shapes or lines you have drawn in.

Button Assign		1/5
1	 Stamp	
2	 Line	
3	 Item Color	
4	 Clear SCR N	

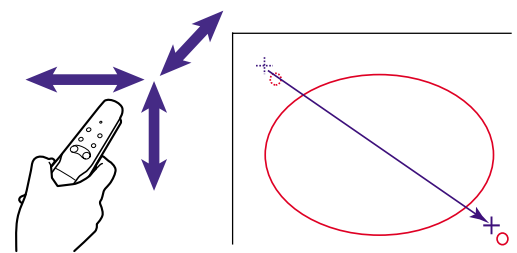
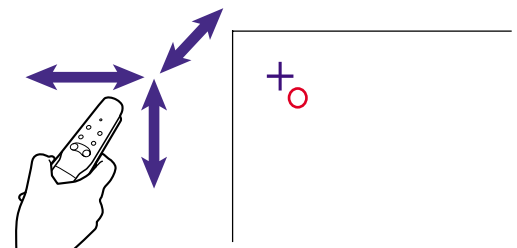
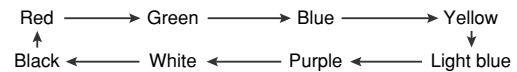
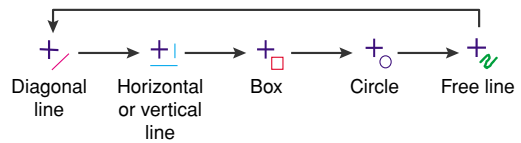

How to draw lines and shapes

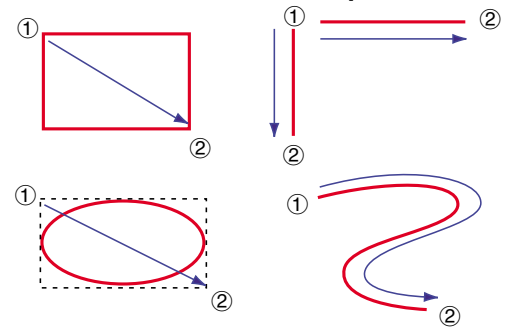

Using the Wireless Presentation Function of the GyroRemote

The remote control can perform mouse operations on a computer screen displayed on the actual screen. The remote control can also be used as a pointer. (See page 44)

Connecting the Computer and the Projector

- 1 Connect the projector to the computer using the supplied USB cable.

Note

- This function only works with Microsoft Windows OS and Mac OS. However, this function does not work with the following operating systems that do not support USB.
 - Versions earlier than Windows 95.
 - Versions earlier than Windows NT 4.0.
 - Versions earlier than Mac OS 8.5.

Supplied accessory

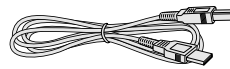

USB cable

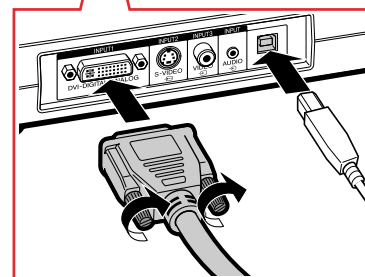
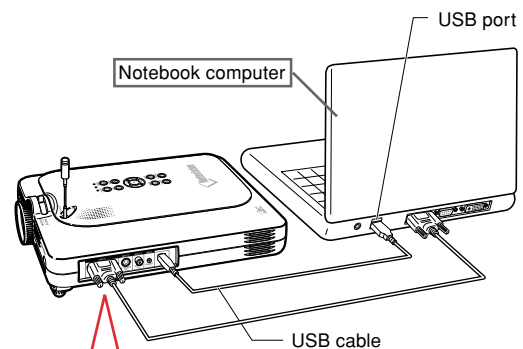



Basic Operation





Using the Wireless Presentation Function of the GyroRemote (Cont.)

Using as a Wireless Mouse

1 Move the GyroRemote while holding down . The LED indicator is lit.

2 Press  or . It functions the same as the buttons of a mouse connected to the computer.

- In the case of one mouse button (such as on a Macintosh) clicking this button will function the same as either  and .

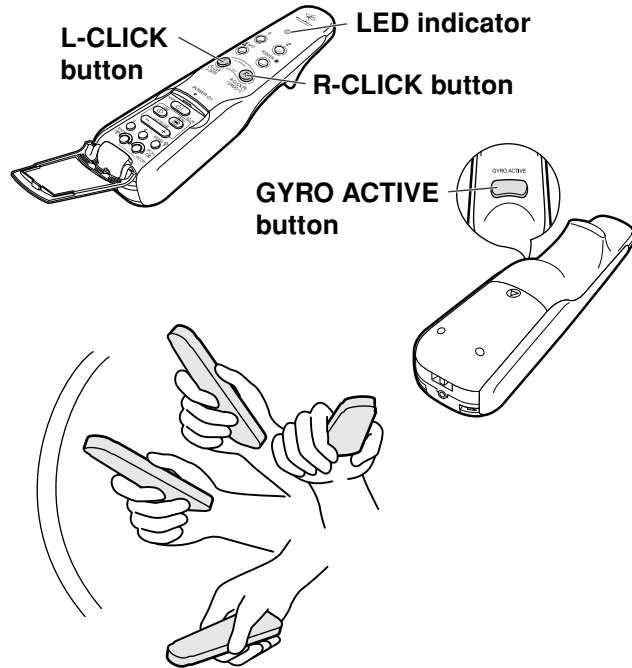

Connecting the GyroRemote with a Cable

Connect the GyroRemote and projector using a cable in places where signal reception is weak.

Note

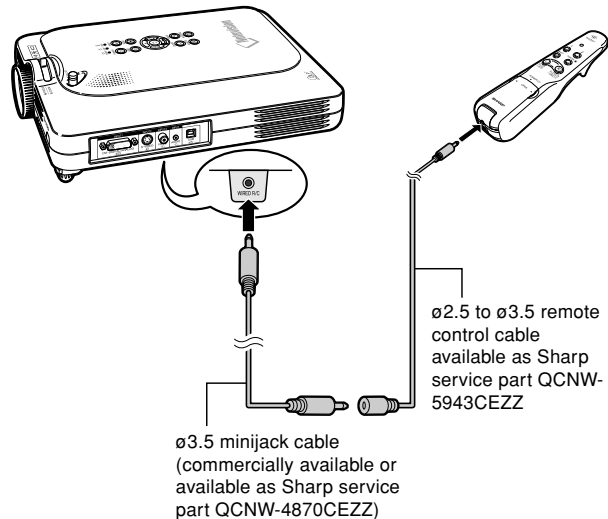

- GyroRemote turns itself off if detached from the $\varnothing 25$ to $\varnothing 3.5$ mm wired remote control cable. To use it again, press  to reactivate.
- When purchasing a $\varnothing 2.5$ to $\varnothing 3.5$ mm wired remote cable, please contact Sharp Authorized Projector Dealer or Service Center.





Turning Off the GyroRemote

Make sure to turn off the GyroRemote to prevent any unwanted operations, when not using the projector. This also prevents consumption of batteries set in the GyroRemote.

- 1 Press  and  located inside the lower cover on the GyroRemote at the same time for more than 2 seconds.

- The LED Indicator will flash 3 times and the GyroRemote will turn off.
- Any buttons pressed after (excluding ) will not emit signals.

- 2 Press  on the GyroRemote to turn on the GyroRemote.

Info

- Make sure to turn off the GyroRemote aboard aircraft or other places where using radio signals is restricted.

Note

GyroRemote Sleep Function

- In order to protect against battery depletion, the GyroRemote automatically enters the Sleep mode when no operation takes places within more than 5 minutes. To cancel the Sleep mode refer to step 2 above.

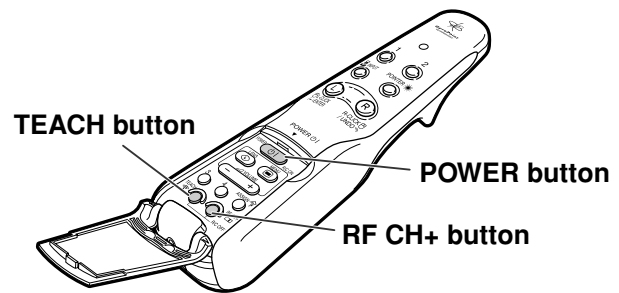



Using the Menu Screen

This projector has three sets of menu screens that allow you to adjust the image and various projector settings. You can operate the menus from the projector or GyroRemote using the following procedure.

On-screen menu for INPUT 1 RGB mode

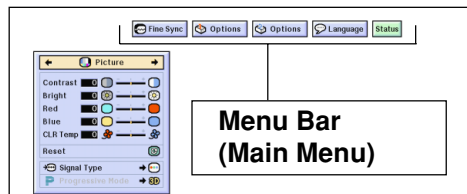

On-screen menu for INPUT 2 or INPUT 3 Mode

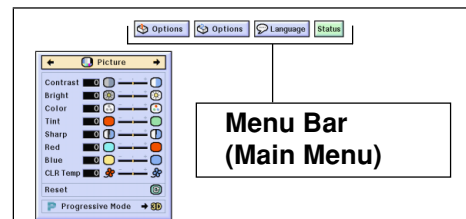

On-screen menu for INPUT 4 RGB mode

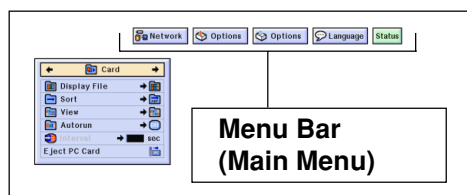

Menu Selections on the Projector (Adjustments)

- 1 Press .
 - The menu screen is displayed.

Note

- The "Picture" menu screen is displayed in inputs 1, 2 and 3 and the "Card" menu screen is displayed in INPUT 4 mode.
- The on-screen display shown on the right is displayed when the INPUT 1 mode is selected.

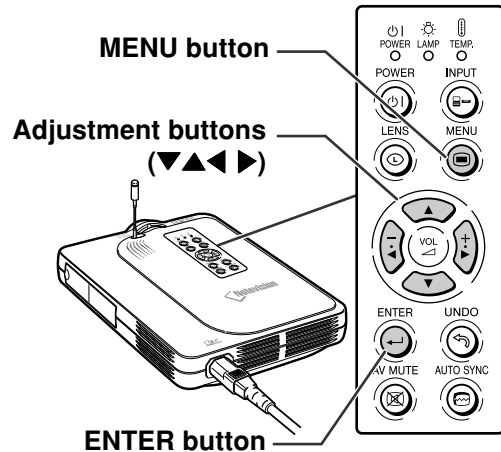

▼ Menu Screen

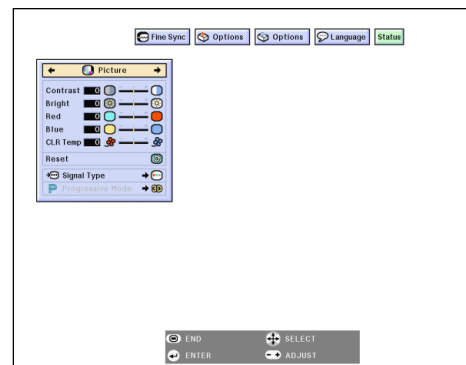



2 Press or to select the menu you want to adjust.

Note

- For details on the menus, see the tree charts on pages 56 and 58.
- When using the GyroRemote to move through a menu, see page 54.

3 Press or to select the item you want to adjust.

Note

- To display a single adjustment item, press after selecting the item. Only the menu bar and the selected adjustment item will be displayed. Then if you press or , the following item ("Phase" is after "Clock") will be displayed.

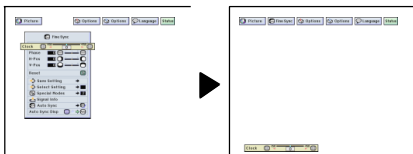

- Press to return to the previous screen.

4 Press or to adjust (set) the item selected.

- The adjustment is stored.

5 Press .

- The on-screen display is cleared.

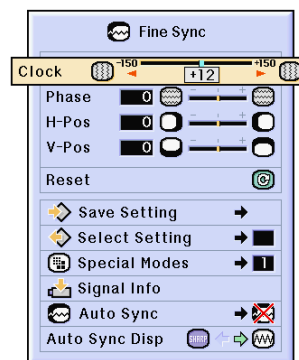
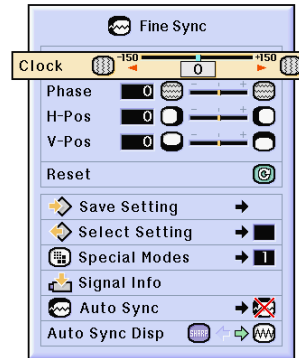
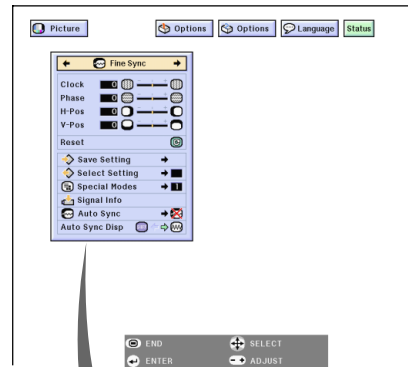

Using the Menu Screen (cont.)



Menu Selections on the projector (Settings)

1 Press .

- The menu screen is displayed.



 **Note**

- The “Picture” menu screen is displayed in inputs 1, 2 and 3 and the “Card” menu screen is displayed in INPUT 4 mode.
- The on-screen display shown on the right is displayed when the INPUT 1 mode is selected.

2 Press  or  to select the menu you want to adjust.

 **Note**

- For details on the menus, see the tree charts on pages 56 and 58.
- When using the GyroRemote to move through a menu, see page 55.

3 Press  or  to select the item you want to set.

 **Note**

- Press  to return to the previous screen.
- In some menus, select the icon using “→”.

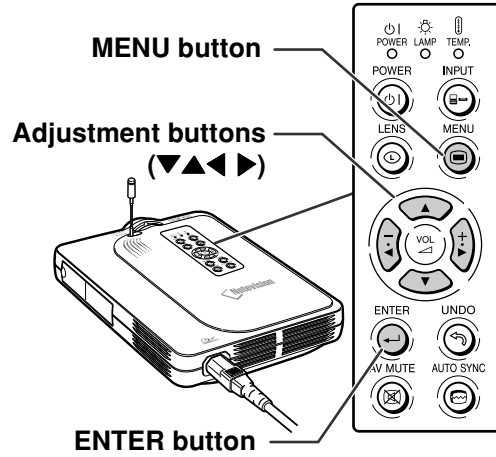

▼ Menu Screen

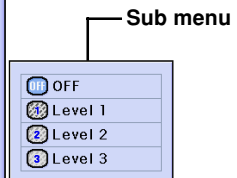
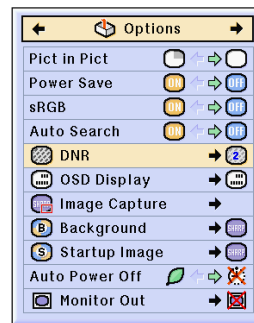
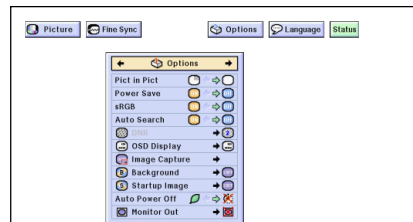
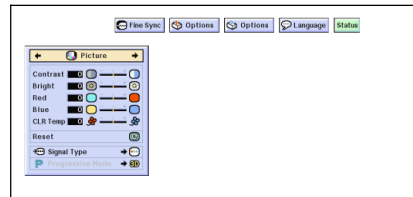



4 Press .

- The cursor shifts to the sub menu.



5 Press or to select the setting of the item displayed in the sub menu.

6 Press .

- The item selected is set.

Note

- Some adjustment items will display a confirmation message.

When setting an item, press  or  to select “Yes” or “OK” and then press .

7 Press .

- The menu will disappear and the adjustment is stored.

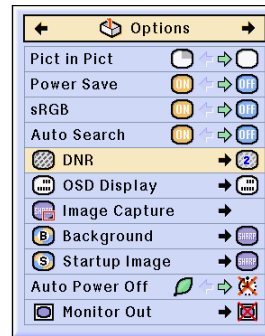
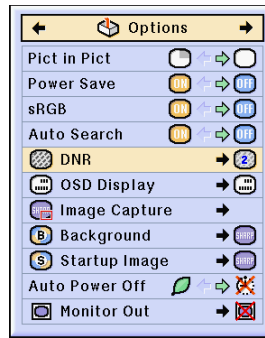



Using the Menu Screen (cont.)

Using the GyroRemote to Navigate the On-screen Menu (Adjustments)

1 Press .

- The menu screen is displayed.

Note

- The “Picture” menu screen is displayed in inputs 1, 2 and 3 and the “Memory Card” menu screen is displayed in INPUT 4 mode.
- The screen on the right shows the INPUT 1 mode screen.

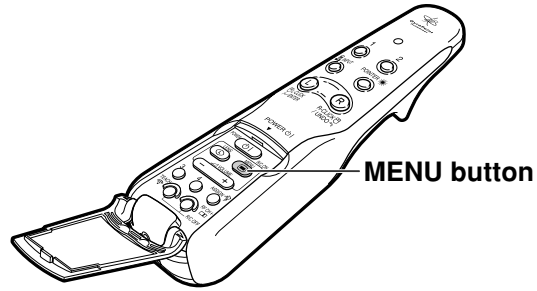



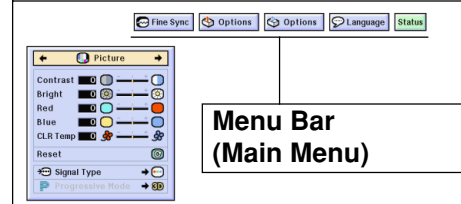



On-screen menu for INPUT 1 mode



2 ① While holding down , move the GyroRemote left and right to select the menu.

Note

- The GyroRemote will not function if  is not held down.
- If  is pressed twice, the  function will remain active without having to hold down . (The LED indicator will remain lit.)
- If  is pressed again, the  function will be released and the LED indicator will turn off.
- If  is pressed on the menu bar, the menu can be selected.

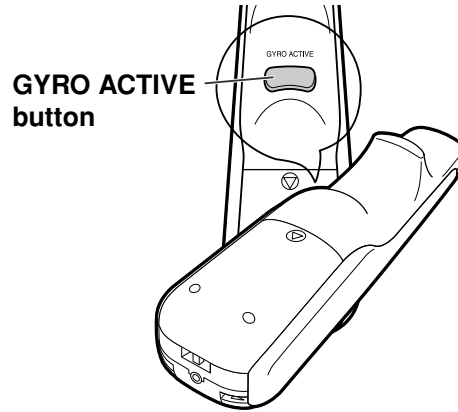

② While holding down , move the GyroRemote up or down to select an item.

③ While holding down , move the GyroRemote to the right and the left to adjust (set) the selected item.

Note

- The adjustment is stored.
- Pressing  can also adjust.

3 Press .

- The menu display disappears.

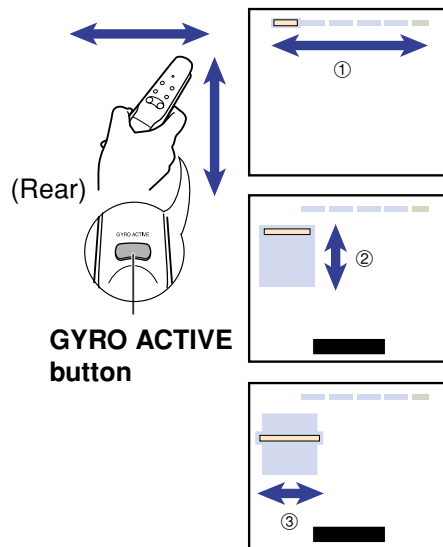

Using the GyroRemote to Navigate the On-screen Menu (Settings)

1 Press .







- The menu screen is displayed.

Note

- The "Picture" menu screen is displayed in inputs 1, 2 and 3 and the "Memory Card" menu screen is displayed in INPUT 4 mode.
- The screen on the right shows the INPUT 1 mode screen.

2 While holding down , move the GyroRemote left and right to select the menu.

Note

- The GyroRemote will not function if  is not held down.
- If  is pressed twice, the  function will remain active without having to hold down . (The LED indicator will remain lit.)
- If  is pressed again, the  function will be released and the LED indicator will turn off.
- If  is pressed on the menu bar, the menu can be selected.

2 While holding down , move the GyroRemote up or down to select an item.

3 While holding down , move the GyroRemote to the right.

- The cursor will move to the sub menu.

4 While holding down , move the GyroRemote up or down to select items on the sub menu.

- The adjustment is stored.

3 Press .

- The menu display disappears.

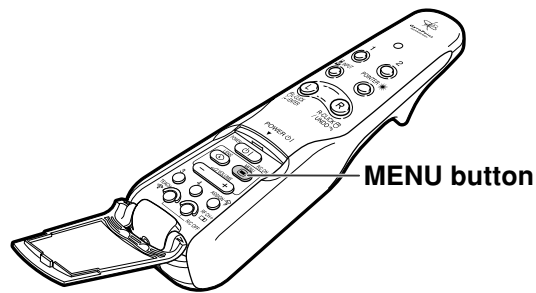

On-screen menu for INPUT 1 mode

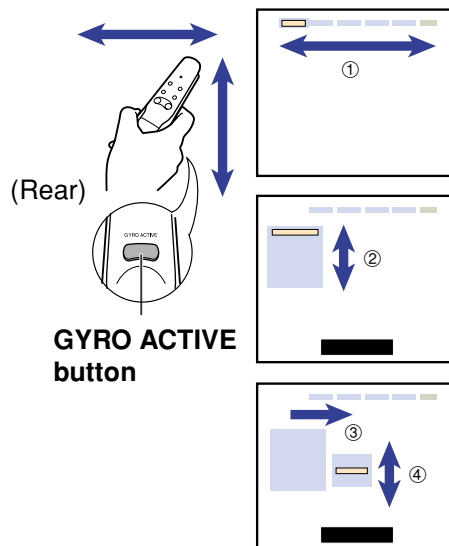
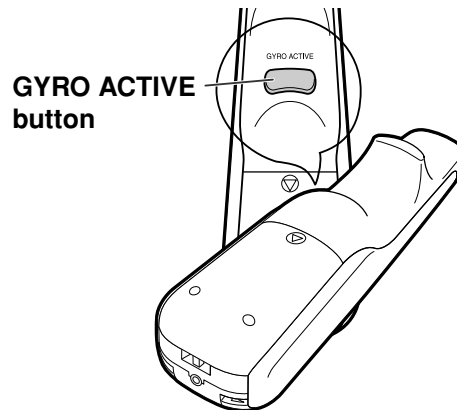
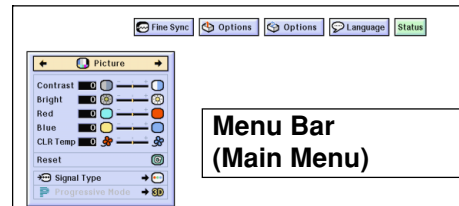



Menu Bar Items

This list shows the items that can be set in the projector.

INPUT 1 Mode

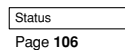
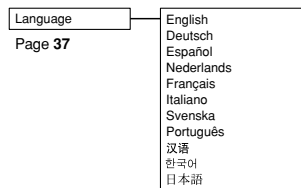
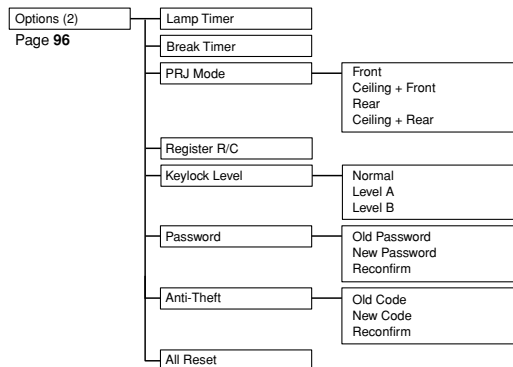
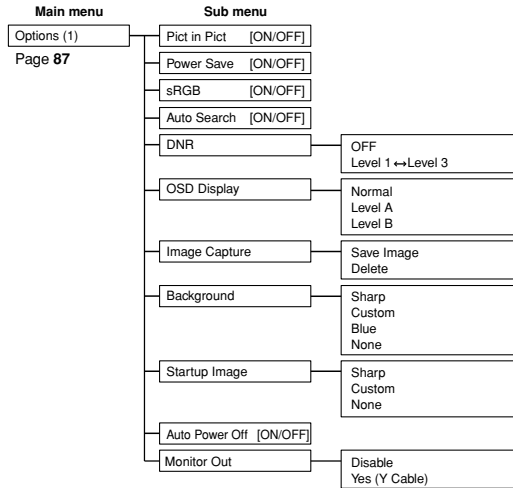
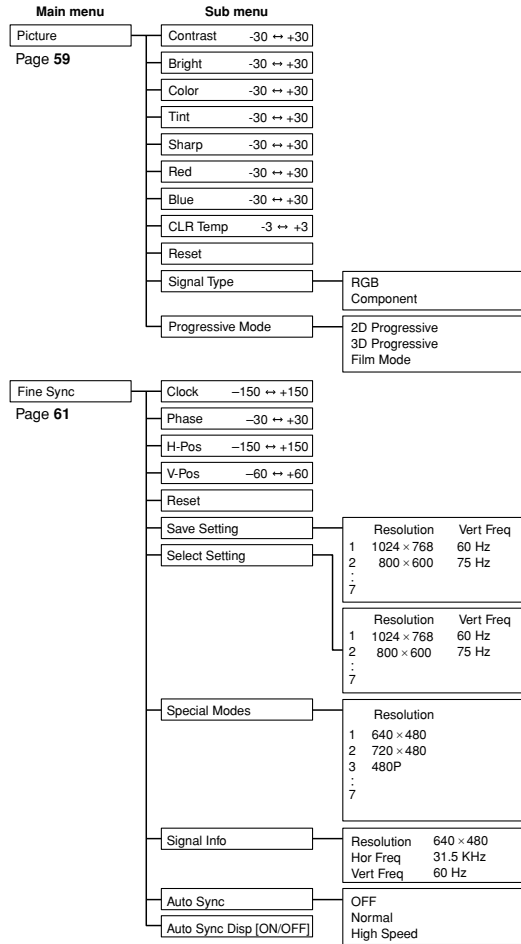

Note

- The resolution, vertical frequency and horizontal frequency figures displayed above are for example purposes only.
- When DVI digital signals have been entered into INPUT 1, in "Picture" only "CLR Temp", "Red" and "Blue" can be adjusted and in "Fine Sync" only "Signal Info", "Auto Sync" and "Auto Sync Disp" can be used.
- When the signal type is set as "Component", in the "Picture" menu of INPUT 1 "Color", "Tint" and "Sharp" are displayed.
- Some items cannot be reset, even when "All Reset" in Options (2) has been selected. For details see page 105.





INPUT 2 / 3 Mode

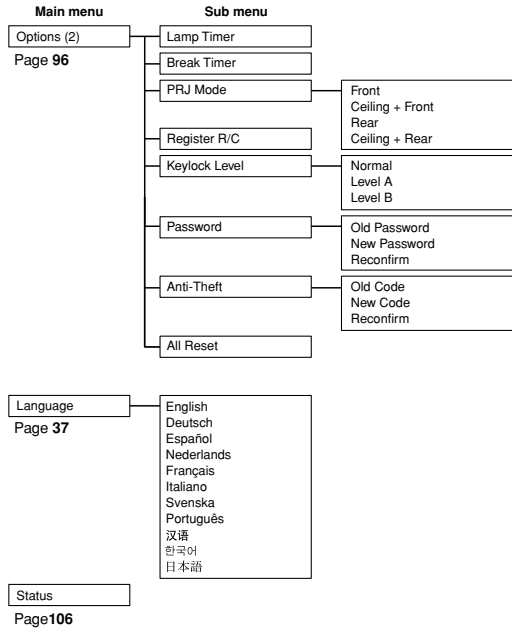
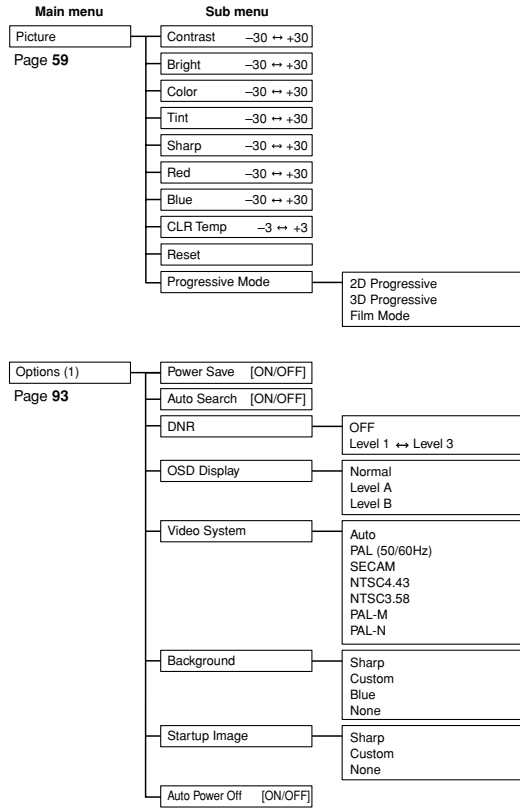

Menu Bar Items (cont.)

This list shows the items that can be set in the projector.

■ INPUT 4 Mode

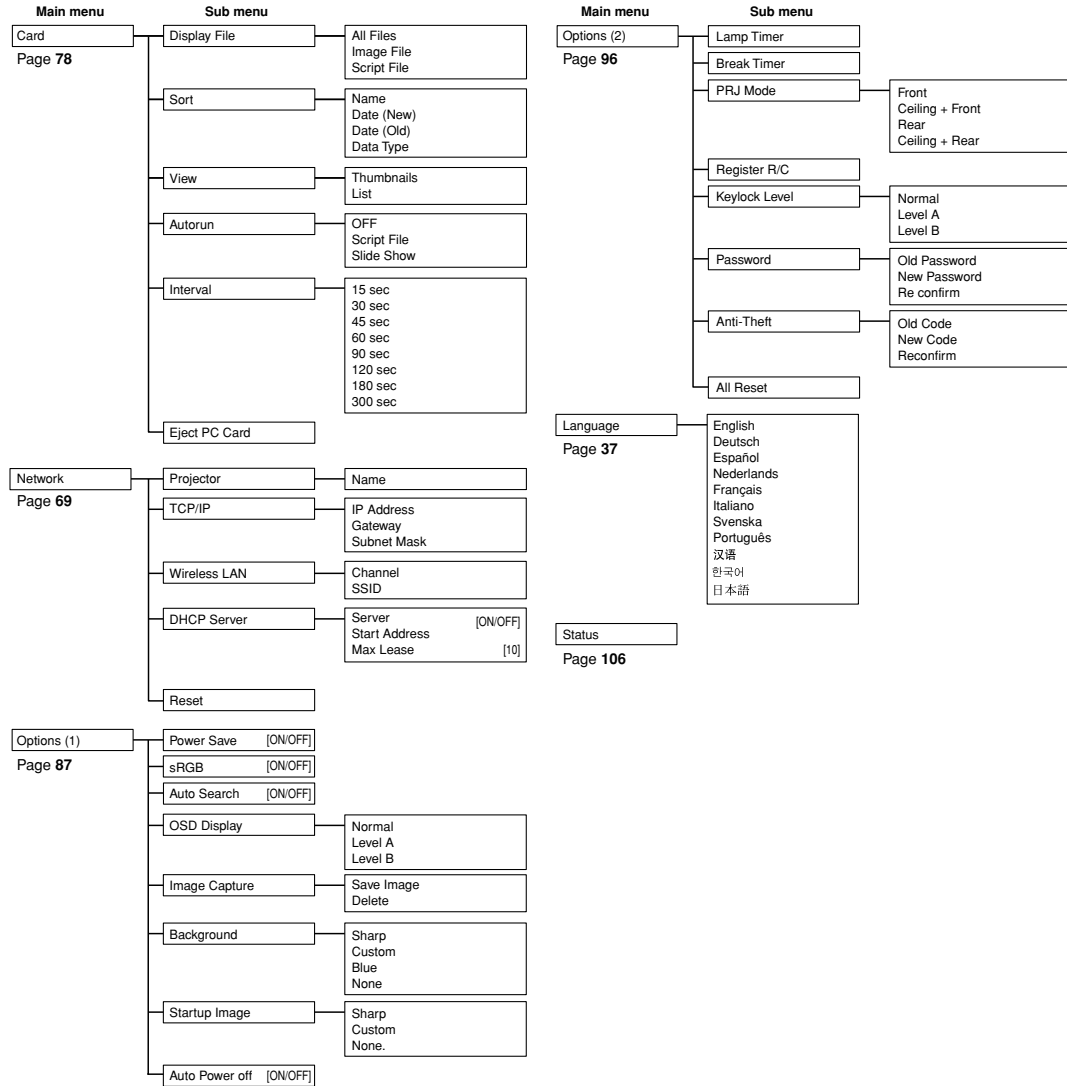

Note

- Some items will not be reset, if you select All Reset in Options (2). For details, see page 105.



Adjusting the Picture

You can adjust the projector's picture to your preferences with the following picture settings.

Selected Item	Description	button	button
Contrast	For adjusting the contrast level	For less contrast	For more contrast
Bright	For adjusting the brightness of an image	For less brightness	For more brightness
Color	For adjusting the color intensity of the image	For less color intensity	For more color intensity
Tint	For adjusting the tones of an image	Skin tones become purplish	Skin tones become greenish
Sharp	For making sharper or softer the contour of an image	For less sharpness	For more sharpness
Red	For adjusting the redness level	For weaker red	For stronger red
Blue	For adjusting the blue level	For weaker blue	For stronger blue
CLR Temp	For adjusting the color temperature of an image	Decreases color temperature for warmer, reddish, incandescent-like images.	Increases color temperature for cooler, bluish, fluorescent-like images.

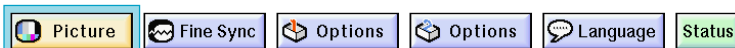

Adjusting Image Preferences

Adjust the Picture menu on the menu screen.

→ For operating the menu screen, see pages 50 and 52.

→ For operating the menu screen using the GyroRemote see pages 54 and 55.

Note

- "Color", "Tint" and "Sharp" are not displayed when selecting INPUT 1 and the "Signal Type" is "RGB".
- The picture adjustments can be stored separately in each input mode.
- When the signal type in INPUT 1 has been set to Component, "Sharp" can be adjusted when 480I, 480P, 720P or 1080I signals are entered.
- To reset all adjustment items, select "Reset" and press .



Selecting the Signal Type

This function allows you to select the input signal type RGB or Component for INPUT1.

Select "Signal Type" in the "Picture" menu on the menu screen.

→ For operating the menu screen, see pages 50 and 52.

→ For operating the menu screen using the GyroRemote see pages 54 and 55.

Note

- RGB
Set when RGB signals are received.
- Component
Set when Component signals are received.

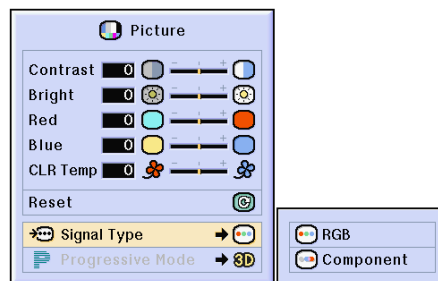

Adjusting the Picture (cont.)

Progressive Mode

This function allows you to select the progressive display of a video signal. The progressive display projects a smoother video image.

Select "Progressive Mode" in the "Picture" menu on the menu screen.

→ For operating the menu screen, see pages 50 and 52.

→ For operating the menu screen using the GyroRemote see pages 54 and 55.

Note

- **2D** 2D Progressive
This function is useful to display fast-moving images such as sports and action films. This mode optimizes the image in a displayed frame.
 - **3D** 3D Progressive
This function is useful to display relatively slow-moving images such as drama and documentary more clearly.
This mode optimizes the image by estimating the movement of a number of preceding and succeeding frames.
 - **Film** Film Mode
Reproduces the image of film source clearly. Displays the optimized image of film transformed with three-two pull down (NTSC and PAL60Hz) or two-two pull down (PAL50Hz and SECAM) enhancement to progressive mode images.
* The film source is a digital video recording with the original encoded as is at 24 frames/second. The projector can convert this film source to progressive video at 60 frames/second with NTSC and PAL60Hz or at 50 frames/second with PAL50Hz and SECAM to play back a high-definition image.
- When using progressive inputs, these inputs are directly displayed therefore 2D Progressive, 3D Progressive and Film Mode cannot be selected. These modes can be selected in interlace signals other than 1080I.
 - In NTSC or PAL60Hz, even if the 3D Progressive mode has been set, the three-two pull down enhancement will be enabled automatically, when the film source has been entered.
 - In PAL50Hz or SECAM, the two-two pull down enhancement will be enabled only in the Film Mode, when the film source has been entered.

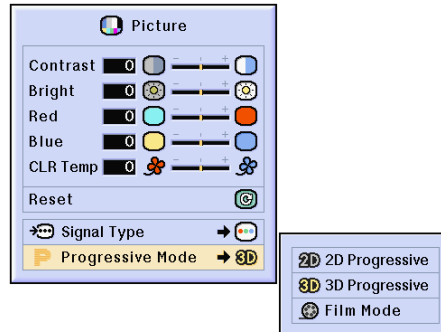



Adjusting Computer Images

Use the Fine Sync function in case of irregularities such as vertical stripes or flickering in portions of the screen.

Selected Item	Description
Clock	Adjusts vertical noise.
Phase	Adjusts horizontal noise (similar to tracking on your VCR).
H-Pos	Centers the on-screen image by moving it to the left or right.
V-Pos	Centers the on-screen image by moving it up or down.

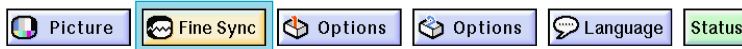

When Auto Sync is OFF

When “Auto Sync” is “OFF”, interference such as flickering or vertical stripes may occur if displaying tilings or vertical stripes. Should this occur, adjust “Clock”, “Phase”, “H-Pos” and “V-Pos” for obtaining an optimum image.

Select “Clock”, “Phase”, “H-Pos” or “V-Pos” in the “Fine Sync” menu on the menu screen.

→ For operating the menu screen, see pages 50 and 52.

→ For operating the menu screen using the GyroRemote see pages 54 and 55.

Note

- Computer image adjustments can be made easily by pressing . See page 63 for details.

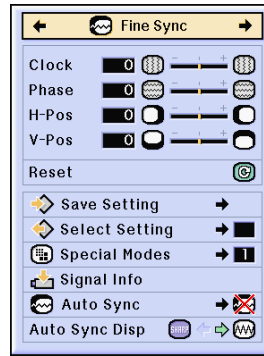

Saving Adjustment Settings

This projector allows you to store up to seven adjustment settings for use with various computers.

Select “Save Setting” in the “Fine Sync” menu on the menu screen.

→ For operating the menu screen, see pages 50 and 52.

→ For operating the menu screen using the GyroRemote see pages 54 and 55.

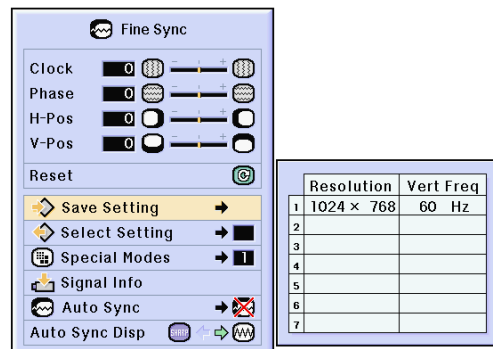

	Resolution	Vert Freq
1	1024 × 768	60 Hz
2		
3		
4		
5		
6		
7		

Basic Operation

Adjusting Computer Images (cont.)

Selecting Adjustment Settings

Adjustment settings stored in the projector can be easily accessed.

Select "Select Setting" in the "Fine Sync" menu on the menu screen.

→ For operating the menu screen, see pages 50 and 52.

→ For operating the menu screen using the GyroRemote see pages 54 and 55.

Note

- If a memory position has not been set, a resolution and frequency setting will not be displayed.
- When selecting a stored adjustment setting with "Select Setting", you can set the projector in the stored adjustments.

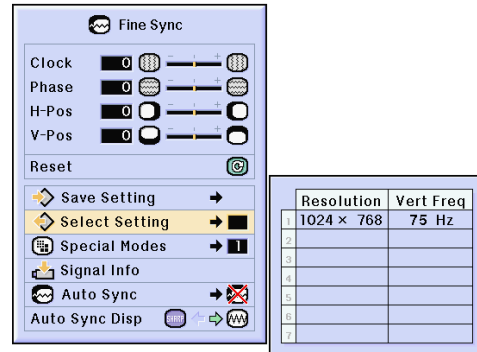

Special Mode Settings

Ordinarily, the type of input signal is detected and the correct resolution mode is automatically selected. However, for some signals, the optimal resolution mode in "Special Modes" on the "Fine Sync" menu screen may need to be selected to match the computer display mode.

Set the resolution by selecting "Special Modes" in the "Fine Sync" menu on the menu screen.

→ For operating the menu screen, see pages 50 and 52.

→ For operating the menu screen using the GyroRemote see pages 54 and 55.

Note

- Avoid displaying computer patterns which repeat every other line (horizontal stripes). (Flickering may occur, making the image hard to see.)
- When a DVD player or Digital Video is connected, select 480P as the input signal.
- See "Checking the Input Signal" below for information on the currently selected input signal.

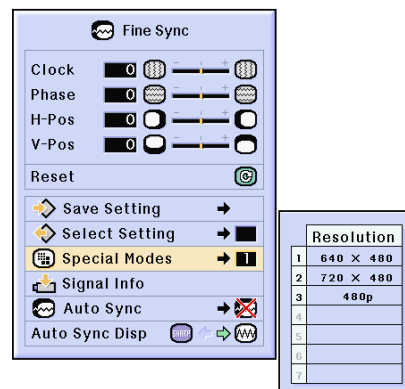

Checking the Input Signal

This function allows you to check the current input signal information.

Select “Signal Info” in the “Fine Sync” menu on the menu screen.

→ For operating the menu screen, see pages 50 and 52.

→ For operating the menu screen using the GyroRemote see pages 54 and 55.

Note

- The projector will display the number of scanned lines available input from audio-visual equipment such as a DVD player or Digital Video.

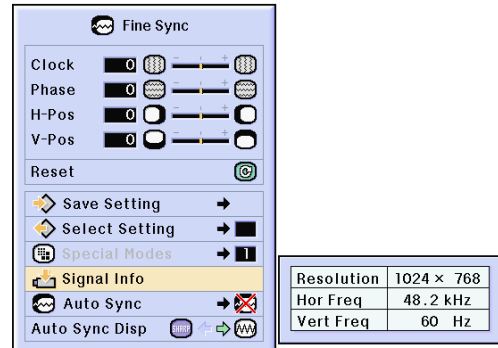

Auto Sync Adjustment

Used to automatically adjust a computer image.

Select “Auto Sync” in the “Fine Sync” menu on the menu screen.

→ For operating the menu screen, see pages 50 and 52.

→ For operating the menu screen using the GyroRemote see pages 54 and 55.

Note

When setting to “Normal” or “High Speed”:

- Auto Sync adjustment will occur when the projector is turned on or when the inputs are switched, when connected to a computer.

Manual adjustments should be performed:

- When the optimum image cannot be achieved with Auto Sync adjustment. See page 61.
- Auto Sync adjustment may take some time to complete, depending on the image of the computer connected to the projector.
- When making adjustments using the AUTO SYNC button on the projector.
- When setting “Auto Sync” to “OFF” or “High Speed”, and if AUTO SYNC is pressed Auto Sync will be executed in “High Speed” mode. If the button is pressed again within one minute, Auto Sync will be executed in “Normal” mode.
- Adjustments can also be made by selecting “Auto Sync” using the Button Assign function.

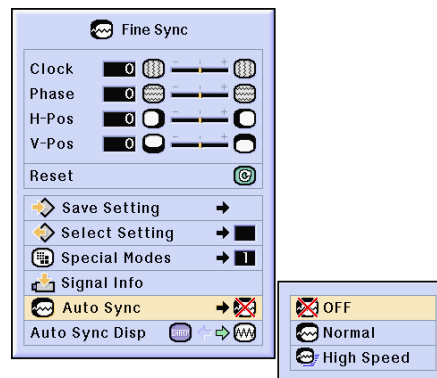

Screen display during Auto Sync

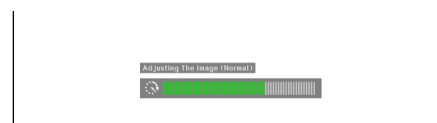



Adjusting Computer Images (cont.)

Auto Sync Display Function



Used to set the screen displayed during Auto Sync.

Select "Auto Sync" in the "Fine Sync" menu on the menu screen.

→ For operating the menu screen, see pages 50 and 52.

→ For operating the menu screen using the GyroRemote see pages 54 and 55.

Note

- The image set as a background image is projected.
- The computer image being adjusted is displayed.

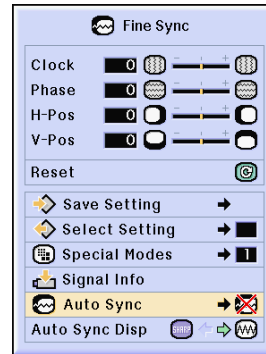

Easy to Use Functions



Easy to Use Functions

Using the Network

Before setting the network

This section explains items that can be set in a network. A wireless connection will not be possible if these items are not set correctly.

Also, as there are values that must be entered in a pre-configured network, make sure to consult with your network administrator.

IP Address

■ When What is an IP Address?

The IP Address is a number for identifying devices connected to the network. An IP address must be assigned to each device using network values.

Connecting the projector and a computer via a wireless connection is the same as the computer and projector being connected to a wireless LAN network. Therefore, if the projector (and computer) is not assigned an IP address, they cannot be identified and thus a wireless connection cannot be possible.

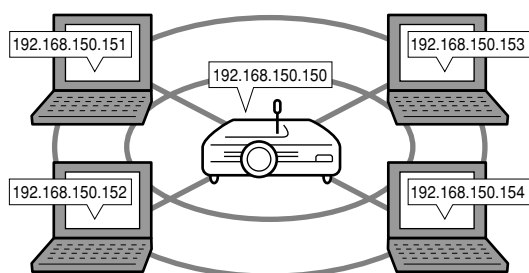

■ Assigning IP addresses

When creating a local network where the projector and a computer are connected in a wireless environment, 192.168.0.1 to 192.168.255.254 can be assigned as the IP addresses for the devices connected to that network.

The IP address of the projector is 192.168.0.1 and as long as there are no conflicts, the default settings do not have to be changed.

Example

- Projector 192.168.150.150
- Computer (no. 1) ... 192.168.150.151
- Computer (no. 2) ... 192.168.150.152

For settings, see page 70.

This projector comes with a DHCP server function that automatically assigns IP addresses to devices connected to the network.

For details, see page 70.

Note

- The range of IP addresses that can be assigned in a local network is fixed.
- IP stands for Internet Protocol.



Wireless Channels

■ What is a wireless channel?

A wireless channel is a frequency used by wireless LAN cards when communicating. 14 channels can be used. If other wireless LAN networks are being used near the location where the projector is, make sure that different channels have been set to avoid interference.

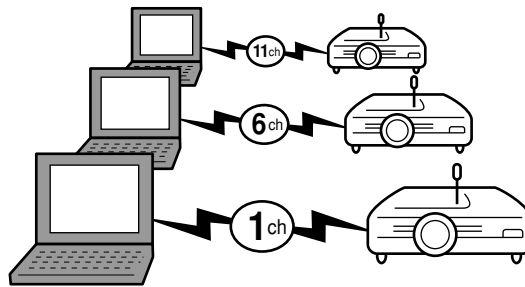

■ Assigned wireless channels

If there are no other networks that can cause interference nearby, set either 1, 6, 13, or 14.

The wireless channel set in the projector is 192.168.0.1 and as long as there are no conflicts, the default settings do not have to be changed.

For settings, see page 71.

DHCP server function

■ What is a DHCP function?

The DHCP server function automatically assigns IP addresses to devices connected to the network. When the Network Settings on the computer have been set to Automatically get IP address (DHCP server enabled), the projector will automatically assign IP addresses.

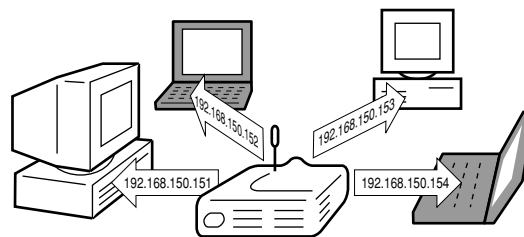

Make the following settings when using this function
Set the DHCP server function on the projector to ON.

Set the start value of the IP address assigned and an expected number of IP address to be automatically assigned (Maximum number to be assigned).

For settings, see page 73.



- DHCP stands for Dynamic Host Configuration Protocol.



Using a Wireless LAN PC Card

Inserting a wireless LAN PC card into the INPUT 4 slot on the projector allows you to send images to the projector and project them via a wireless connection.

Installing a Wireless LAN PC Card

1 Insert the wireless LAN PC card into the INPUT 4 slot on the projector.

- For details on how to install the card, see page 31.
- When the card is inserted, the input will automatically change to INPUT 4.

Note

- See page 75 when installing a memory card in the projector.
- Installation should be done after “Stand-by” is displayed.

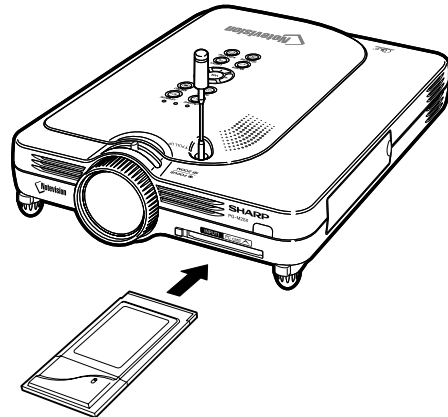

Ejecting the Card

Make sure to perform the following procedures before removing the card. Select “Eject PC Card” in the Card menu on the menu screen.

→ For operating the menu screen, see pages 50 and 52.

→ For operating the menu screen using the GyroRemote see pages 54 and 55.

1 Select “Eject PC Card” and press .

- After a few seconds, the message “You may safely eject the PC Card” will be displayed.

2 Remove the card.

- Remove the card after the message is displayed.

Info

- When moving the projector, make sure that the Eject button is pressed all the way in. If moved with the Eject button out, the projector may be damaged.

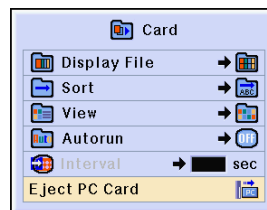

You may safely eject the PC Card.

Network Settings

Note

- This section explains items that can be set in a network. A wireless connection will not be possible if these items are not set correctly.
- Also, as there are values that must be entered in a pre-configured network, make sure to consult with your network administrator.

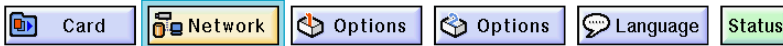

Setting Up a Projector Name

This Network setting assigns a name to the projector. The default setting is "MY PROJECTOR". When selecting "Projector" in the network menu on the menu screen → For operating the menu screen, see pages 50 and 52.

→ For operating the menu screen using the GyroRemote see pages 54 and 55.

1 Press or to select "Projector" and then press .

2 Press in "Name".

3 Press or to select the characters you want to set.

Note

- The following characters can be entered: Letters (A-Z), numbers (0-9) or symbols (-, _, (,), BS).
- Pressing or switches between procedures as shown below.
- If you want to delete one character to the left, select "BS" by pressing or and press .
- The projector name is displayed when the projector has been found via the computer.

4 Press .

Note

- If you want to correct a letter or symbol, press or to move the cursor to the character you want to correct, and then use or to correct the character.
- Characters can also be selected using on the GyroRemote.
- If you want to cancel the settings, press .

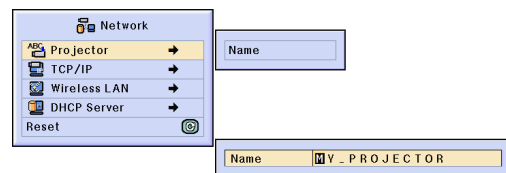
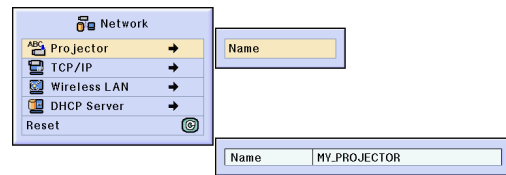

Easy to Use Functions

Network Settings (cont.)

5 Repeat steps 3 and 4 to enter the remaining characters you want.

Note

- A maximum of 16 characters can be entered

6 Press .
• The settings are stored and active.



Setting the IP Address



Set the IP Address of the projector.



Set "TCP/IP" in the network menu on the menu screen.



→ For operating the menu screen, see pages 50 and 52.

→ For operating the menu screen using the GyroRemote see pages 54 and 55.



1 Press  or  to select TCP/IP and then press .

2 Press  or  to select "IP Address", and then press .

3 Press  or  to select the values you want to set.

4 Press  or  to move the cursor to the digit you want to correct.

Note

- You can also move the cursor by pressing  on the GyroRemote.
- If you want to cancel the settings, press .

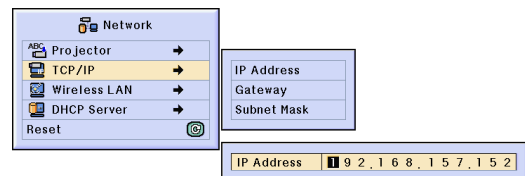
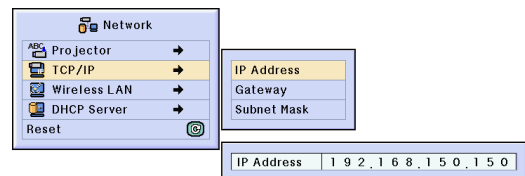

5 Repeat steps 3 and 4 to set all the digits.

Setting the Gateway

Select “Gateway” using the procedure in step 1, and enter the values by repeating the procedure in step 3 and 4.

Setting the Subnet Mask

Select “Subnet Mask” using the procedure in step 1, and enter the values by repeating the procedure in step 3 and 4.

6 Press .



Setting the Wireless Channel



Set the wireless LAN channel so that no interference occurs with another wireless channel.



Select “Wireless LAN” in the network menu on the menu screen.

→ For operating the menu screen, see pages 50 and 52.

→ For operating the menu screen the GyroRemote see pages 54 and 55.

1 Press  or  to select “Wireless LAN” and the press .

2 Press  or  to select “Channel” and then press .

3 Press  or  to select the wireless channel number you want to set.

Note

- Depending on the country and geographical location, wireless channels that can be used are limited. Read the Wireless LAN PC Card Cautions about the wireless channels that can be used.
- The channels that can be used are from channel 1 to 11 depending on the country.

4 Press .

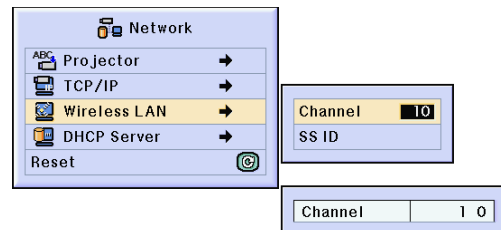

Network Settings (cont.)

Setting the SSID

Set the projector's SSID.

The default setting is "SHARP_PRJ".

Select "Wireless LAN" in the network menu on the menu screen

→ For operating the menu screen, see pages 50 and 52.

→ For operating the menu screen using the GyroRemote see pages 54 and 55.

1 Press or to select "Wireless LAN" and then press .

2 Press or to select "SS ID" and then press .

3 Press or to select the characters you want to set.

Note

- The characters can be entered following:
Letters (A to Z), numerical (0 to 9), symbols (-, _, ())
- If you want to delete one character to the left, select "BS" and press .

4 Press .

- You can also move the cursor using on the GyroRemote.

Note

- If you want to correct a letter or symbol, press or to move the cursor to the character you want to correct, and then use or to correct the character.
- If you want to cancel the settings, press .

5 Repeat steps 2 and 3 to set all the characters.

Note

- A maximum of 16 characters can be set.

6 Press .

- The settings are enabled.

GB-72

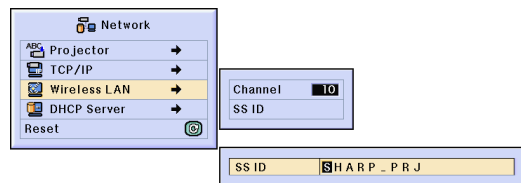
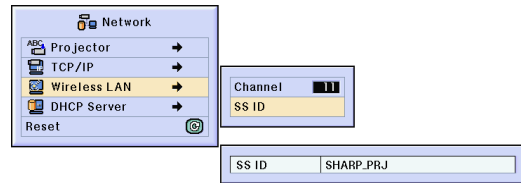

Setting the DHCP Server

This function is set when using the DHCP server on the projector.

Set “DHCP Server” in the network menu on the menu screen.

→ For operating the menu screen, see pages 50 and 52.

→ For operating the menu screen using the GyroRemote see pages 54 and 55.

Enabling the DHCP server function

Set the “Server” in the submenu to “ON”.

Set the “Server” to “OFF” when not using the DHCP server function.

Note

- When the DHCP server function of the projector has been set in a wireless LAN where there is another DHCP server connected, the network may not function correctly. If there is another DHCP server connected, make sure to consult with your Network Administrator.

Setting the Assign “Start Address”

Set the Assign Start Address in Start Address in the Submenu.

For setting the start address, see the procedure in **Setting the IP Address**.

Assigning a maximum number of IP addresses

This function is for setting the maximum number of IP addresses from the start address that can be automatically assigned.

Make sure to set an approximate amount of the computers that are to be connected to the wireless LAN.

You can set anywhere between 1 to 250 computers.

Note

- Assign “Start Address” and “Max Lease” can be set when the DHCP server function is OFF.
- IP addresses will not be sorted if their number is more than 250.

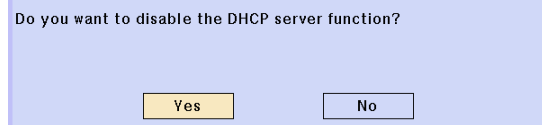
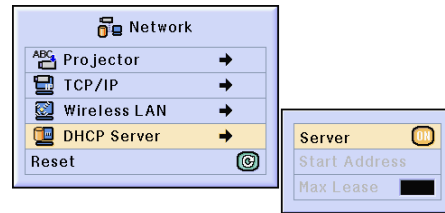

↓ Select “Yes”

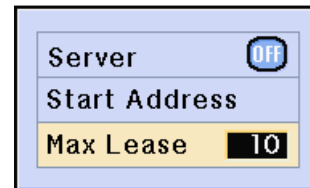
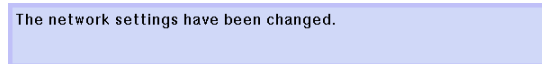

Network Settings (cont.)

Resetting the Network Settings

This will return the default values of the Network Settings.

Select "Reset" in the Network menu on the menu screen.

→ For operating the menu screen, see pages 50 and 52.

→ For operating the menu screen using the GyroRemote see pages 54 and 55.

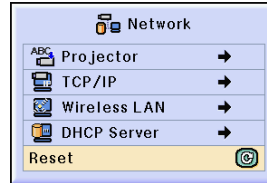

Wireless LAN PC card: Troubleshooting

Check the following if you cannot connect to the network using your wireless LAN PC card.

1. Is the Link indicator o the wireless LAN PC card light?

- Lit: operating normally.
- Flashing: the wireless LAN PC card driver is not operating properly. Reinstall the driver in the computer.
- Off: The card is not in operation. Make sure that the card is installed correctly.

2. Are the SSID, channel and wireless transmission settings of the projector and computer the same?

- If the SSID, channel and wireless transmission settings of the computer are not the same, then they cannot communicate.
- When communicating with the projector, make sure that the transmission mode has been set to 802.11 ad hoc mode.

3. Check the projector and computer network settings.

- When the DHCP "Server" on the projector is "OFF":
Check again the IP address, subnet mask and gateway values of the projector and computer.
- When the DHCP server on the projector is ON:
Check the values of the IP address, subnet mask and DHCP assigned start address of the projector.
If part of the IP address or DHCP assign start address is not identical to the ones specified in the subnet mask, IP address assigning cannot be properly done.

IP address	192.168.150.120
Subnet mask	255.255.255.0
Assign start address	192.168.150.100...correct
Assign start address	192.168.050.100...wrong

If the above procedure is carried out and the wireless LAN PC card still does not operate, see the Wireless Reality software operation manual.



Using a Memory Card

When a memory card is installed, images stored in the memory card can be projected. If presentation files are stored in the memory card you can make presentations using only the projector and the memory card, without having to use a computer.

Displaying of the Contents in the Card as an Index

- 1 Insert the memory card into the **INPUT 4** terminal on the projector.
 - For details on installing the card, see page 31.
 - The current mode will automatically change to INPUT 4 mode, when the PC Card is inserted into INPUT 4 terminal, and the files stored in the card will be displayed as an index. (Index mode)

Note

- For details about the display format of the Index mode, see pages 76,77.
- For details on how to install the wireless LAN card in the projector, see page 68.
- The following are the files that this projector can handle.
 - Non-compressed Bitmap (.BMP)
 - JPEG files (.JPEG / .JPG)
 - Non-compressed TIFF files (.TIFF / .TIF)
 - VQ files (.VQ)
 - Script files (.SSF)

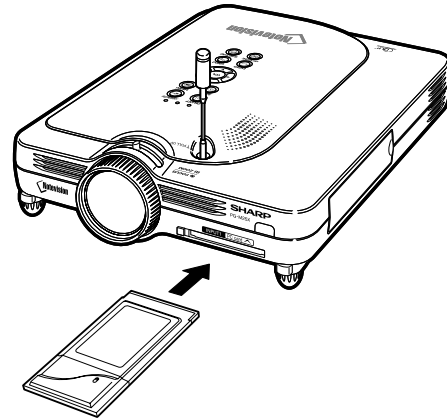

Ejecting the Card

Make sure to perform the following procedures before removing the card.

Select Card eject in the Card menu on the menu screen

→ For operating the menu screen, see pages 50 and 52.

→ For operating the menu screen using the GyroRemote see pages 54 and 55.

- 1 Select **“Eject PC Card”** and press .
 - After a few seconds, the message “You may safely eject the PC Card” will be displayed.

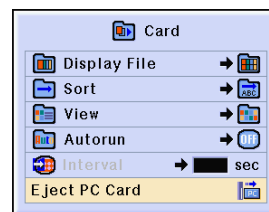

You may safely eject the PC Card.

Using a Memory Card (cont.)

2 Remove the card.

- Remove the card after the message is displayed.
- For details on how to remove the card, see page 31.

Info

- When moving the projector, make sure that the Eject button is pressed all the way in. If moved with the Eject button out, the projector may be damaged.

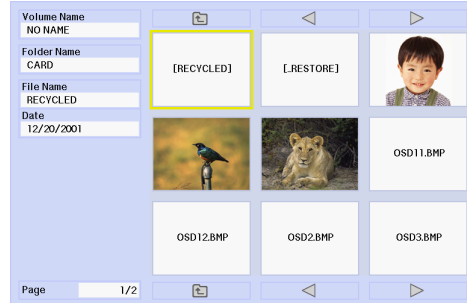

Setting the Thumbnail Display

You can display JPEG files and slide show VQ files as thumbnails. Some files may not be displayed as thumbnails.

Images files that cannot be displayed as thumbnails or other files except images will be displayed only as file names.

- Other file names except for folders, image files, and script files will be displayed in gray.
- The folders are displayed in [].
- The file names will be displayed in 8 characters with their extensions (3 characters).

Moving folders

- Press or to select the folder and press .
- To move the folder up one level, select and press .

Projecting a file

- Press or to select the folder and press .
- The selected image is displayed.
- If you press while the image is displayed, the submenu is displayed.
 - "Next" Proceeds to the next page.
 - "Previous" Moves back one page.
 - "Rotate (right)" ... Turns the image to the right by 90°.
 - "Rotate (left)" ... Turns the image to the left by 90°.
 - "Index" Quits automatic display of images. The screen returns to Index mode.

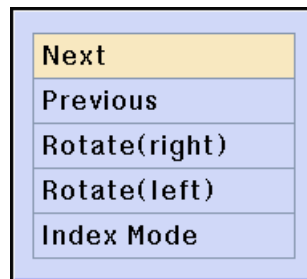

Changing the page displayed







- Select or and press .

GB-76





Setting Lists

You can display files in lists.
For list settings, see page 78.

Moving files

- Press    or  to select the folder and press .
- To move the folder up one level, select  and press .

Projecting a file

- Press  or   or  to select the folder and press .
- The selected image is displayed.

Changing the page displayed

- Select  or  and press .

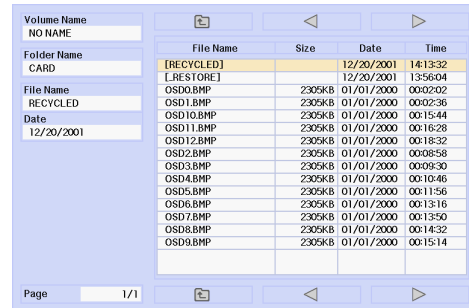

File Name	Size	Date	Time
[RECYCLED]		12/20/2001	14:13:32
[RESTORE]		12/20/2001	13:56:04
OSD0.BMP	2305KB	01/01/2000	00:02:32
OSD1.BMP	2305KB	01/01/2000	00:02:36
OSD10.BMP	2305KB	01/01/2000	00:15:44
OSD11.BMP	2305KB	01/01/2000	00:16:28
OSD12.BMP	2305KB	01/01/2000	00:18:32
OSD2.BMP	2305KB	01/01/2000	00:08:58
OSD3.BMP	2305KB	01/01/2000	00:09:30
OSD4.BMP	2305KB	01/01/2000	00:10:46
OSD5.BMP	2305KB	01/01/2000	00:11:56
OSD6.BMP	2305KB	01/01/2000	00:13:16
OSD7.BMP	2305KB	01/01/2000	00:13:50
OSD8.BMP	2305KB	01/01/2000	00:14:32
OSD9.BMP	2305KB	01/01/2000	00:15:14



Memory Card Settings

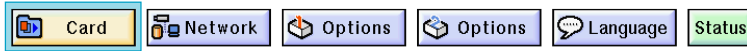

Setting Files

You can limit the files displayed in the Index mode according to their type.

Select “Display File” in the Memory Card menu on the menu screen.

→ For operating the menu screen, see pages 50 and 52.

→ For operating the menu screen using the GyroRemote see pages 54 and 55.

Note

- All Files
All the files and folders are displayed.
- Image File
Only images files and folders are displayed. The types of images files that can be displayed are as follows:
JPEG, VQ, TIFF, BMP.
- Script File (.SSF)
Only slide show script files and folders are displayed.

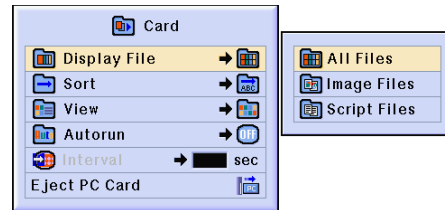

Setting the Display Order of Files

You can set the display order of files displayed in the Index mode.

Select “Sort” in the Memory Card menu on the menu screen.

→ For operating the menu screen, see pages 50 and 52.

→ For operating the menu screen using the GyroRemote see pages 54 and 55.

Note

- Files can be displayed in:
- Name or alphabetical order.
 - New date order
 - Old date order
 - File type order

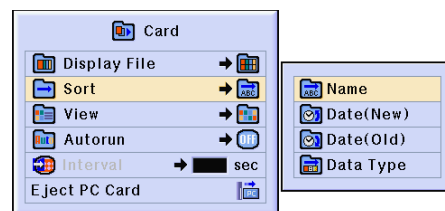

Setting the Display Format of the Index Mode

Select "View" in the Memory Card menu on the menu screen.

→ For operating the menu screen, see pages 50 and 52.

→ For operating the menu screen using the GyroRemote see pages 54 and 55.

Note

- Thumbnail display
For displaying the contents of the memory card as thumbnails.
- List display
For displaying the contents of the memory card in a list.

Using Autorun

The Autorun function works under the following cases:

- When the projector is turned on with the card installed.
- When installing the card while the projector is on.

Select "Autorun" in the Memory Card menu on the menu screen.

→ For operating the menu screen, see pages 50 and 52.

→ For operating the menu screen using the GyroRemote see pages 54 and 55..

"OFF"

For disabling the Autorun function.

"Script File"

When the script files which are created by Slide Manager of the Wireless Reality are stored in the memory card, the Auto-Run will automatically load the script files and then projects the image files in order according to the script files.

- The display interval between images is regulated in the script file.
- The script file can be made using the slide manager included with your projector.

"Slide Show"

The image files stored in the root directory in the memory card will be projected in order automatically.

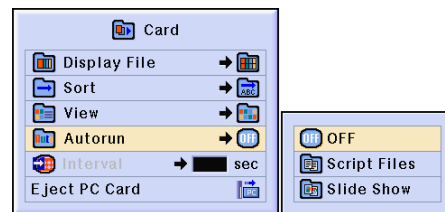
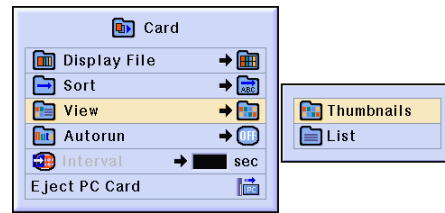

Memory Card Settings (cont.)

Setting the Display Interval for Image Files

You can set the display interval for slide show files (image files).

Adjust “Interval” in the Memory Card menu on the menu screen.

→ For operating the menu screen, see pages 50 and 52.

→ For operating the menu screen using the GyroRemote see pages 54 and 55.



Pressing the  button during image protection via the Autorun function will display the submenu.

- “Next” Proceeds to the next page.
- “Previous” Moves back one page.
- “Index Mode” ... Quits automatic display of images. The screen returns to Index mode.

Info

- Pressing any button on the projector or on the GyroRemote during Autorun, the Autorun function stops.

Note

- During Slide Show playback, the OSD message “Please wait” will appear between slides. This message can be eliminated by selecting “ Level A” or “ Level B” in “OSD Display” See page 89 to disable OSD messages.

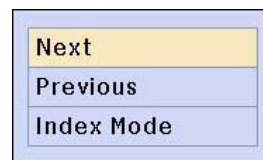
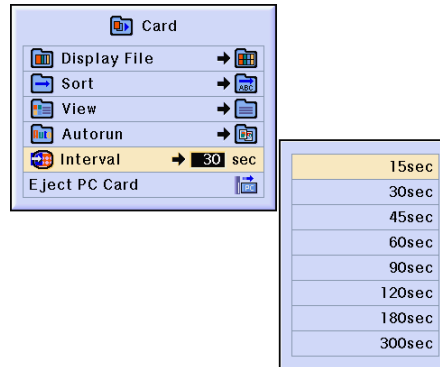





Displaying a Still Image

This function allows you to instantly freeze a moving image. This is useful when you want to display a still image from a computer or video, giving you more time to explain the image to the audience.

Storing an Image in Still Image Format

For using the GyroRemote, see page 40 for details.

- 1 Press  to display "Button Assign 2/5".
 - The Assign function is displayed at the bottom right of the screen.

- 2 Press .
 - The image currently being projected becomes a still image.

- 3 Press  again to return to the moving image from the currently connected device.

Info

- Still picture functions 4 do not work in the in INPUT 4.

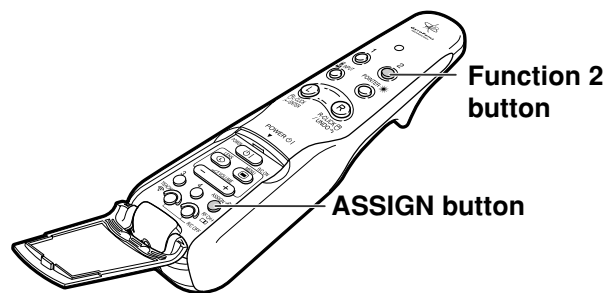

▼ On-screen Display





Selecting the Picture Display Mode

This function allows you to modify or customize the picture display mode to enhance the input image. Depending on the input signal, you can choose “NORMAL”, “FULL”, “DOT BY DOT”, “BORDER”, “STRETCH” or “SMART STRETCH” image.

Switching the Picture Display Using Different Input Signals

For using the GyroRemote, see page 40 for details.

- 1 Press  to display “Button Assign 4/5”.
 - The Assign function is displayed at the bottom right of the screen.

- 2 Press .

Info

- In the “DOT BY DOT” mode, images are displayed with the original resolution, therefore they are not enlarged.
- To return to the previous mode, press  while “RESIZE” is displayed on the screen.

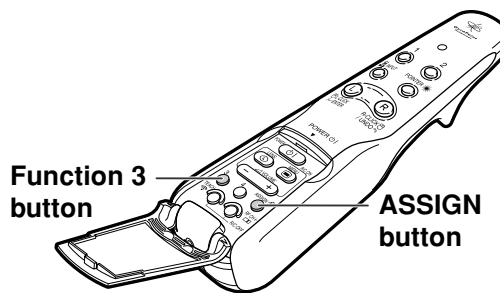

Screen display of the picture display mode





COMPUTER

		NORMAL	FULL	DOT BY DOT
4:3 aspect ratio	SVGA (800 × 600)	1024 × 768	—	800 × 600
	XGA (1024 × 768)	1024 × 768	—	—
	SXGA (1280 × 960)	1024 × 768	—	1280 × 960
	UXGA (1600 × 1200)	1024 × 768	—	1600 × 1200
Other aspect ratios	SXGA (1280 × 1024)	960 × 768	1024 × 768	1280 × 1024

- When XGA (1024 x 768) signals have been entered or when using INPUT 4 Mode, they will be fixed as NORMAL.

Input Signal		Output screen image		
		NORMAL Projects a full screen image while maintaining the aspect ratio.	FULL Projects a full screen image while ignoring the aspect ratio.	DOT BY DOT Projects the original resolution signal of the image.
Resolution lower than XGA	 4:3 aspect ratio			
XGA	 4:3 aspect ratio			
Resolution higher than XGA	 4:3 aspect ratio			
SXGA (1280 × 1024)				

VIDEO

		NORMAL	BORDER	STRETCH	SMART STRETCH
480I, 480P, NTSC PAL, SECAM	4:3 aspect ratio. Letter box, squeeze	1024 × 768	768 × 576*	1024 × 576*	1024 × 576*
720P, 1080I	16:9 aspect ratio	—	—		

- *"STRETCH" is fixed when 720P or 1080I signals are entered.
- * The Digital Shift function can be used with these images.

Input Signal		Output screen image			
		NORMAL Projects a full screen image.	BORDER Projects 4:3 image fully in STRETCH (the following column) image.	STRETCH Projects 16:9 image evenly over entire screen (top/bottom black bands).	SMART STRETCH Projects the image fully in a 16:9 screen by enlarging only the surrounding areas while keeping the aspect ratio in the middle part of the image at 4:3.
480I, 480P, NTSC, PAL, SECAM	 4:3 aspect ratio				
	 Letter box				
	 Squeeze				
720P, 1080I	 16:9 aspect ratio	—	—		—

Selecting the Picture Display Mode (cont.)

This function allows you to enlarge a specific portion of an image. This is useful when you want to display a detailed portion of the image.

Displaying an Enlarged Portion of an Image

For using the GyroRemote, see page 40 for details.

1 Press  to display "Button Assign 3/5".

- The Assign function is displayed at the bottom right of the screen.

2 Press Function Button  to enlarge the image.

- To reduce the size of the enlarged image, press Function Button .

Note

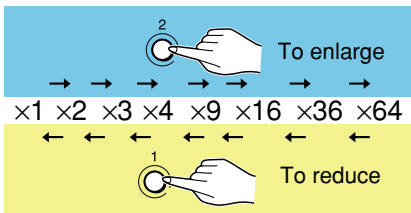





- When an SXGA+ or UXGA image is displayed, "x2" and "x3" cannot be selected.

3 Hold down  and move the GyroRemote to move the enlarged image.

- If the Screen moving mark has disappeared, press Function Button  to display the Screen move mark, and then move the image.

Note

- You can also move the position of the enlarged image using  or  or  or  on the projector.

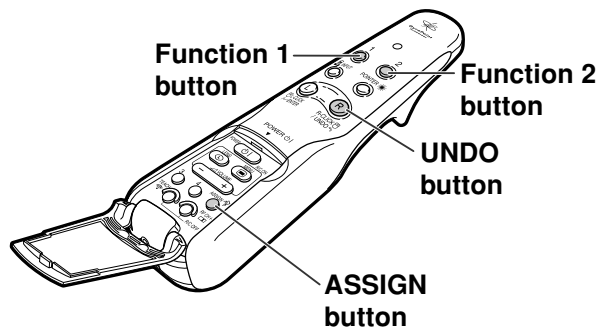

On-screen Display

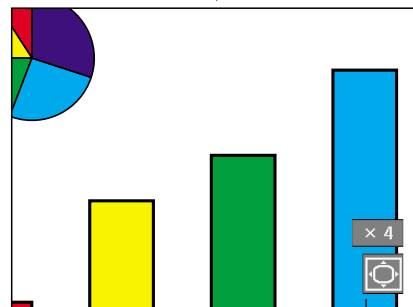
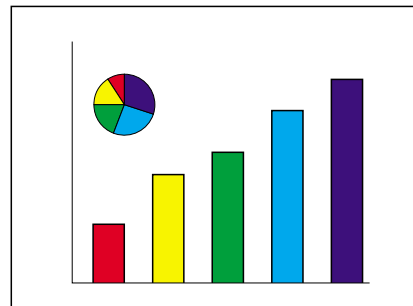

Screen moving indicator



4 Press  to cancel the operation, then the magnification returns to $\times 1$.

 **Note**

- In the following cases, the enlarged image will return to its original size ($\times 1$).
- When switching the input.
- When  (undo) has been pressed.
- When the input signal has been changed.
- When the input signal resolution or refresh rate (vertical frequency) has been changed.



Gamma Correction Function

Gamma is an image quality enhancement function that offers a richer image by brightening the darker portions of the image without altering the brightness of the brighter portions. When you are displaying images with frequent dark scenes, such as a film or concert, or when you are displaying images in a bright room, this feature makes the dark scenes easier to see and gives the impression of greater depth in the image.

Selected Mode	Description
STANDARD	For Standard picture
PRESENTATION	Brightens darker portions of image for more enhanced presentations.
CINEMA	Gives greater depth to darker portions of image for a more exciting theater experience.
GAME	Natural color gradation for playing a game, etc.

Adjusting Gamma Correction

For using the GyroRemote, see page 40 for details.

1 Press  to display "Button Assign 4/5".

- The Assign function is displayed at the bottom right of the screen.

2 Press .

- You can change the gamma correction type every time you press this button.

3 To reset default settings, press  when "Gamma" is displayed.

Note

• Returning to the following gamma modes.

INPUT mode	INPUT signal	GAMMA mode
INPUT1	RGB	PRESENTATION
	Component	CINEMA
INPUT2	S-Video	STANDARD
INPUT3	Video	STANDARD
INPUT4	—	PRESENTATION

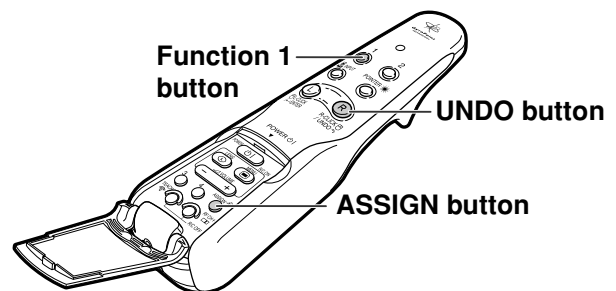

STANDARD

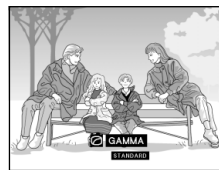

GAME



PRESENTATION

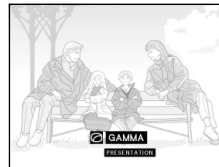

CINEMA

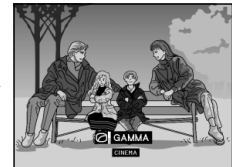



Selecting the Power Save Mode

The Power Save Mode or the Automatic Power Shutoff function allows you to reduce the power consumption of the projector.

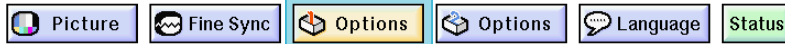

Setting the Power Save Mode

Select "Power Save" in the "Options (1)" menu on the menu screen.

→ For operating the menu screen, see pages 50 and 52.

→ For operating the menu screen using the GyroRemote see pages 54 and 55.

Description of Power Save Modes

ON	Quantity of light is 80%. Power consumption is XXXW.
OFF	Quantity of light is 100%. Power consumption is 295W.

Note

- It is set to "OFF" normally.
- "Power Save" mode is factory preset to "OFF".
- When setting the power save mode to "OFF", the projected images become dark.

Automatic Power Shutoff Function

When no input signal is detected for more than 15 minutes, the projector will automatically shut off if set to "On".

The Auto Power Off function will be disabled when it has been set to "Off".

Select "Auto Power Off" in the "Options (1)" menu on the menu screen.

→ For operating the menu screen, see pages 50 and 52.

→ For operating the menu screen using the GyroRemote see pages 54 and 55.

Note

- When the Auto Power Off function is set to "On", 5 minutes before the power turns off, the message "Power OFF in X min." will appear on the screen to indicate the remaining minutes.

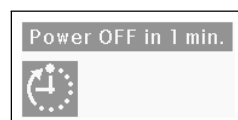
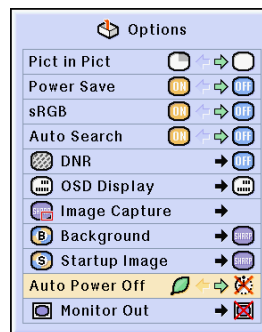
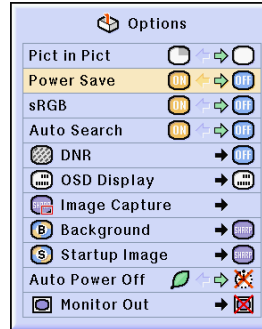

Easy to Use Functions



Displaying Dual Pictures (Pict in Pict)

Picture in Picture function allows you to display two pictures on the same screen. You can display the image input from INPUT 2 or 3 as an inset picture overlapping the main picture from INPUT 1. (This function can only be set in the RGB menu.)



Displaying the Inset Picture

Select "Pict in Pict" in the "Options (1)" menu on the menu screen. Make sure to operate when INPUT 1, INPUT 2 and INPUT 3 all have signals.

→ For operating the menu screen, see pages 50 and 52.

→ For operating the menu screen using the GyroRemote see pages 54 and 55.

1 Press to select .

- When operating with the GyroRemote, press to display "Button Assign 3/5" and press .
- P in P does not function with INPUT 4.

2 Press to change the image in the inset picture.

3 Press to set the position of the inset picture.

- Press to stop the frame from moving or to make the frame disappear.

Note

- Hold down and move the GyroRemote in all directions, when moving the position of the inset picture using the GyroRemote.

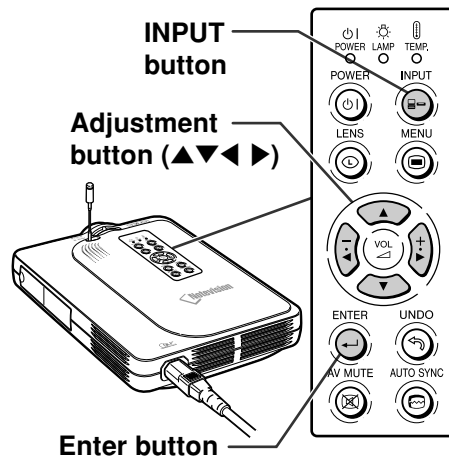



4 Press to move the inset picture.

- The inset picture will be moved to the inset picture frame.

Note

- The inset picture can only be displayed with composite video (NTSC/PAL/SECAM) or S-Video signal.
- The Freeze function works only with the inset picture, when the Pict in Pict mode is in operation.

When the signal entered into INPUT 1 is as follows, Pict in Pict does not work:

- With a resolution that exceeds SXGA.
- When the input signal is 480I, 480P, 720P or 1080I.
- When the input signal has changed to the Interlace mode using RGB signals.
- When the picture display mode is set to "DOT BY DOT".
- When no signals are sent to INPUT 1, or when the resolution or refresh rate (vertical frequency) is changed.
- You can use  on the GyroRemote or  on the projector to change the inset picture.

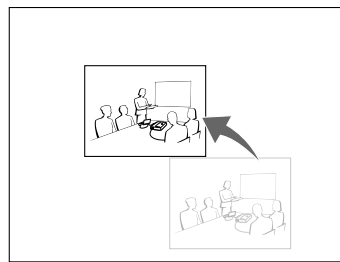
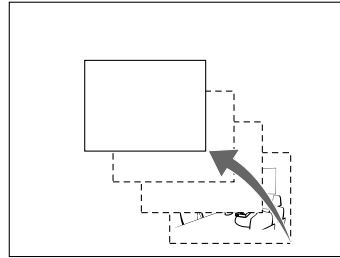

Setting On-screen Display

This function allows you to turn on or off the on-screen messages. When setting " Level B" in "OSD Display", the input mode display (e.g. "INPUT 1") will not appear, even if the INPUT button is pressed.

Selected Item	Description
<input checked="" type="radio"/> Normal	All On-screen Displays are displayed.
<input type="radio"/> Level A	Input/Freeze/Enlarge/Auto Sync/Volume/AV Mute are not displayed.
<input type="radio"/> Level B	All On-screen Displays are not displayed. (except Menu, On-screen displays displayed when the LENS button is pressed, and warning displays (Power off/Temp./Lamp, etc.))

Turning Off the On-screen Display

Select "OSD Display" in the "Options (1)" menu

→ For operating the menu screen, see pages 50 and 52.

→ For operating the menu screen using the GyroRemote see pages 54 and 55.

Note

- Standby message in INPUT 4 will appear regardless of "OSD Display" level.

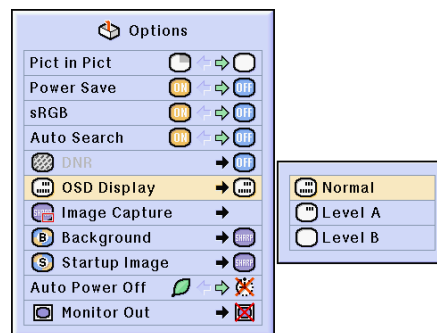

Activating the sRGB Color Management Function

This function calibrates the projector's output to confirm to sRGB standard (6,500K).

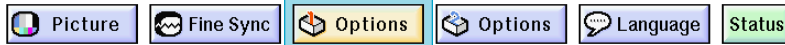

Setting the Color Management Function (sRGB)

Select "sRGB" in the "Options (1)" menu on the menu screen.

→ For operating the menu screen, see pages 50 and 52.

→ For operating the menu screen using the GyroRemote see pages 54 and 55.

Note

- For additional information about sRGB function, please visit "<http://www.srgb.com/>".

Info

- When setting sRGB to "ON", the projected image may become dark; however, this does not indicate a malfunction. When "sRGB" is set to "ON";
- The gamma correction cannot be set.
- "Red", "Blue" or "CLR Temp" in "Picture" cannot be adjusted.





Auto Search Function

This function automatically searches for and switches to the input mode in which signals are being received, when the projector is turned on, or when the INPUT button is pressed. This function does not work with INPUT 4 mode.

Using Auto Search



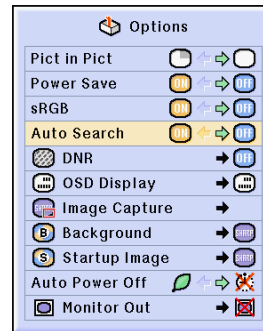

Select "Auto Search" in the "Options (1)" menu on the menu screen.

→ For operating the menu screen, see pages 50 and 52.

→ For operating the menu screen using the GyroRemote see pages 54 and 55.



Note

-  **ON**
 Automatically switches to the input mode in which signals are being received, when turning on the projector or pressing  on the projector.
- When the Auto Search function has been set to ON, select any desired input, using the Button Assignment.
-  **OFF**
 For switching input modes manually in order by pressing  on the projector.
- To stop searching for the input mode, press  on the projector or on the GyroRemote.

Video Digital Noise Reduction (DNR) System

Video Digital Noise Reduction (DNR) provides high quality images with minimal dot crawl and cross color noise.



Reducing Image Noise

Select "DNR" in the "Options (1)" menu.

→ For operating the menu screen, see pages 50 and 52.

→ For operating the menu screen using the GyroRemote see pages 54 and 55.

Note

- Set a level so as to view a clearer picture.

Make sure to set DNR to "OFF" in the following cases:

- When the image is blurry.
- When the contours and colors of moving images drag.
- When TV broadcasts with weak signals are projected.

Info

- Make sure to set when signals have been input into INPUT 2 or INPUT 3.
- This function is available with INPUT 1 (480I and 480P signals) and INPUT 2, 3 (all signals).

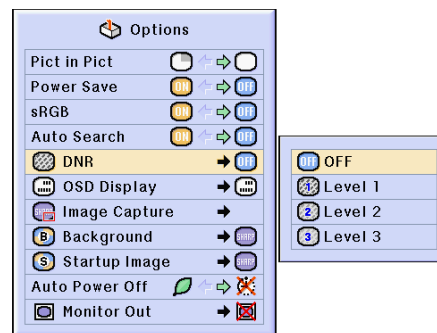



Setting the Video Signal

The video input system mode is preset to “Auto”; however, a clear picture from the connected audio-visual equipment may not be received, depending on the video signal difference. In that case, switch the video signal.



Setting the Video Signal

Select “Video System” in the “Options (1)” menu on the menu screen.

→ For operating the menu screen, see pages 50 and 52.

→ For operating the menu screen using the GyroRemote see pages 54 and 55.

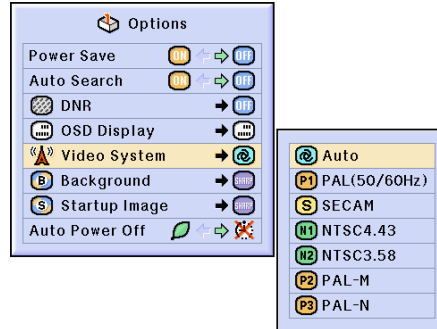

Note

- The video signal can only be set in INPUT 2 or INPUT 3 mode.
- In “Auto”, images are displayed in PAL even if PAL-N or PAL-M input signals are received.

PAL	When connected to PAL video equipment.
SECAM	When connected to SECAM video equipment.
NTSC4.43	When reproducing NTSC signals in PAL video equipment.
NTSC3.58	When connected to NTSC video equipment.

Selecting a Startup Image

This function allows you to specify the image to be displayed upon the projector’s startup.

Selected Item	Description
Sharp	SHARP default image
Custom *	User customized image (i.e. company logo)
None	Black screen

* You can set a captured image as a startup image by selecting “Custom”.

Selecting a Startup Image

Select “Startup Image” in the “Options (1)” menu on the menu screen.

→ For operating the menu screen, see pages 50 and 52.

→ For operating the menu screen using the GyroRemote see pages 54 and 55.

Note

- When “Custom” is selected, an image saved using “Image Capture” can be displayed as a startup image.
- A “Custom” image is preset as a black screen.

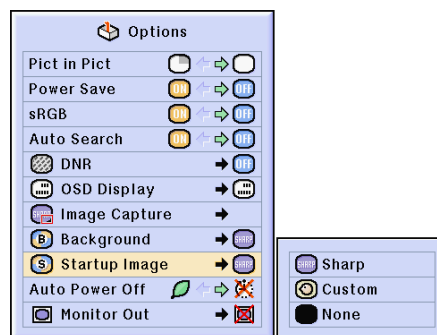

Easy to Use Functions



Saving Projected Images

- This projector allows you to capture projected images (RGB signals) and set them as a startup image, or background image when no signals are being received.
- You can capture the images that are input using analog RGB signals and Digital RGB XGA signals.



Capturing the Image

Select "Image Capture" in the "Options (1)" menu on the menu screen

→ For operating the menu screen, see pages 50 and 52.

→ For operating the menu screen using the GyroRemote see pages 54 and 55.

1 Press or to select

" Save Image" and press



- The projected image is captured. It may take some time for capturing.

2 **1** Press or to select "Yes".

2 Press .

Note

- This function only works in 1024 x 768 (XGA) with the exception of 43 Hz vertical which is a interlaced signal.
- The saved image is reduced to 256 colors.
- Images from equipment connected to INPUT 2 or 3 or images in INPUT 4 (card) cannot be captured.

Deleting the Captured Image

1 Select " Delete" and press .

2 **1** Press or to select "OK".

2 Press .

GB-94

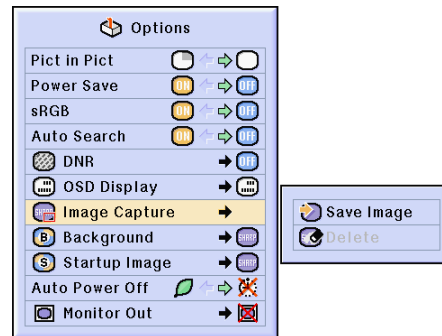

Do you want to save this image as a custom image in the projector?
(Previously saved custom image will be deleted.)

Yes

No

This custom image saved in the projector will be deleted.

OK

Cancel



Setting a Background Image

This function allows you to select the image displayed when no signal is being sent to the projector.

Selected Item	Description
Sharp	SHARP default image
Custom ^{*1}	User customized image (i.e. company logo)
Blue	Blue screen
None	Black screen ^{*2}

*1 You can set a captured image as a background image by selecting "Custom".

*2 If the input signal has interference, the screen will be displayed with the interference.

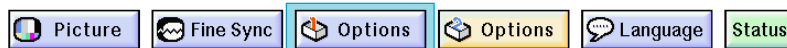

Selecting a Background Image

Select "Background" in the "Options (1)" menu on the menu screen.

→ For operating the menu screen, see pages 50 and 52.

→ For operating the menu screen using the GyroRemote see pages 54 and 55.

Note

- When "Custom" is selected, an image saved using "Image Capture" can be displayed as a background image.
- A "Custom" image is preset as a black screen.

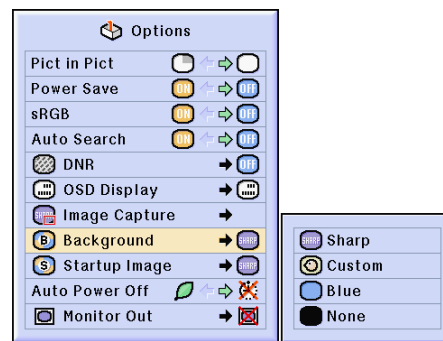

Using an RGB Monitor Loop-out Adaptor

Using an RGB monitor loop-out adaptor (sold separately) and an RGB cable (commercially available), be sure to set to Yes (Y Cable) when you want to display computer images both on the projector and on a monitor.



Using an RGB Monitor Loop-out Adaptor

Select "Monitor Out" in the "Options (1)" menu on the menu screen.

→ For operating the menu screen, see pages 50 and 52.

→ For operating the menu screen using the GyroRemote see pages 54 and 55.

Note

- Be sure to set to Disable when not using an RGB monitor loop-out adaptor.
- If the setting is not correct, the image may be dark, too bright or whitish. This does not indicate malfunction.
- Make sure to set to Yes (Y Cable) when using the RGB monitor loop-out adaptor.

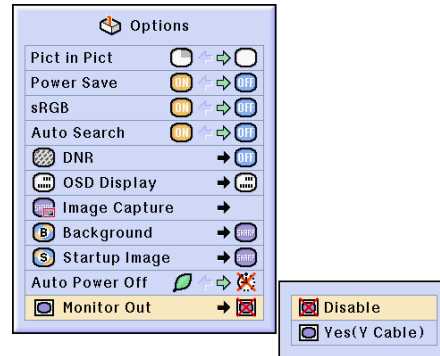

Displaying the Lamp Usage Time

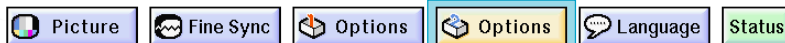

Confirming the Lamp Usage Time

This function allows you to check the lamp usage time.

Select "Options (2)" menu on the menu screen to see the lamp usage time.

→ For operating the menu screen, see pages 50 and 52.

→ For operating the menu screen using the GyroRemote see pages 54 and 55.

Note

- It is recommended that the lamp be changed after approximately 1,900 cumulative hours of use. For lamp replacement, contact your nearest Sharp Authorized Projector Dealer or Service Center.

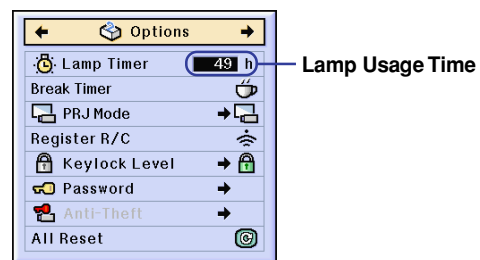

Displaying the Break Timer

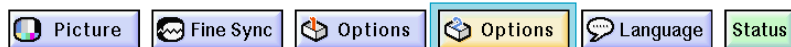



Displaying and Setting the Break Timer

Select “Break Timer” from the “Options (2)” menu on the menu screen.

→ For operating the menu screen, see pages 50 and 52.

→ For operating the menu screen using the GyroRemote see pages 54 and 55.

1 When “☕” is displayed, press  or  to set the Break Timer.

- You can set anywhere between 1 and 60 minutes (in 1 minute units).

To cancel the break time

1 Press Undo on the remote control or press R on the remote control.

Note

- When using the GyroRemote, set the Break time using the GyroRemote (see page 41).
- Auto Power Off will be temporarily disabled during the Break Timer.
If no signal transmission occurs for more than 15 minutes after the Break Timer has completed, the projector will turn off.
- The Break Timer will be displayed on the startup image. To change the screen displayed during the Break Timer, change the setting of “Startup Image” (see page 95).

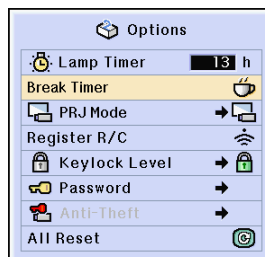

▼ On-screen Display



Reversing/Inverting Projected Images

This projector is equipped with a reserve/invert image function that allows you to reverse or invert the projected image for various applications.

Selected Item	Description
Front	Normal image
Ceiling + Front	Inverted image
Rear	Reversed image
Ceiling + Rear	Reversed and inverted image

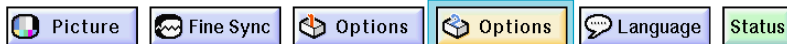

Setting the Projection Mode

Select "PRJ Mode" in the "Options (2)" menu on the menu screen.

→ For operating the menu screen, see pages 50 and 52.

→ For operating the menu screen using the GyroRemote see pages 54 and 55.

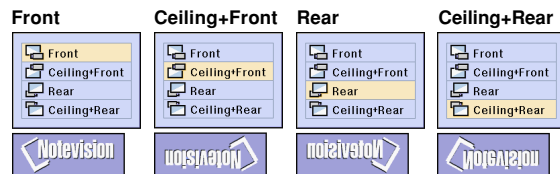
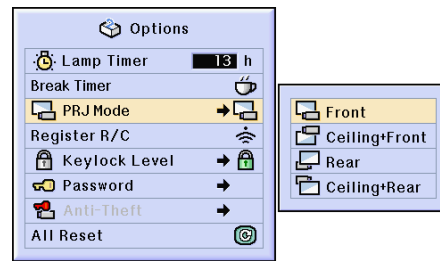

Note

- If a password has been set, the password input box will be displayed when selecting the "PRJ Mode".
- This function is used for the reversed image and ceiling-mount setups. See page 25 for these setups.



Locking the Operation Buttons on the Projector

This function can be used to lock the use of certain operation buttons on the projector. The following are the three keylock levels.

Keylock Level	Description
 Normal	All operation buttons are functional.
 Level A	Only INPUT/VOLUME/AV MUTE buttons on the projector are available.
 Level B	All operation buttons on the projector are unavailable.

Setting up the Keylock

Select “Keylock Level” in the “Options (2)” menu on the menu screen.

→ For operating the menu screen, see pages 50 and 52.

→ For operating the menu screen using the GyroRemote see pages 54 and 55.

Note

- If a password has been set, the password input box will be displayed when selecting the “Keylock Level”.

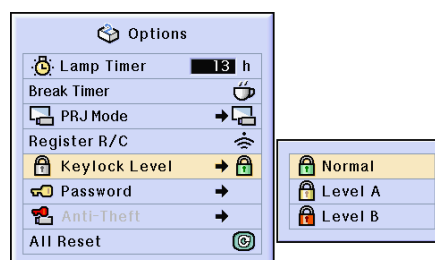

Canceling the Keylock Setting

When the Keylock Level is set to “Normal”, all buttons are functional.

Select “Keylock Level” in the “Options (2)” menu and set “ Normal” on the menu screen.

→ For operating the menu screen, see pages 50 and 52.

→ For operating the menu screen using the GyroRemote see pages 54 and 55.

Note

- When a password has been set, and “Keylock Level” is selected, the password input box will be displayed.
- If both a password and the Keylock Level have been set at the same time, the password will be necessary before changing the Keylock Level.

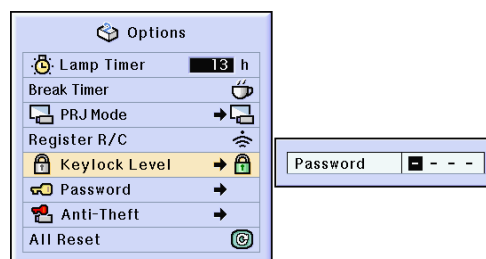

Setting up a Password

A password can be set by the user to prevent adjustments to certain settings on the “Options (2)” menu. Using a password together with the Keylock Level (page 99) is more effective.

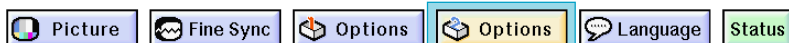

Entering the Password

Select “Password” in the “Options (2)” menu on the menu screen

→ For operating the menu screen, see pages 50 and 52.

→ For operating the menu screen using the GyroRemote see pages 54 and 55.

1 Press or to select the desired number and then press .

2 Enter the 3 remaining digits and press .

3 Enter the password again in “Reconfirm” and press .

Note

- When a password is set, you need to enter the password to change “PRJ Mode”, “Keylock Level”, “Anti-Theft” and “All Reset” settings.

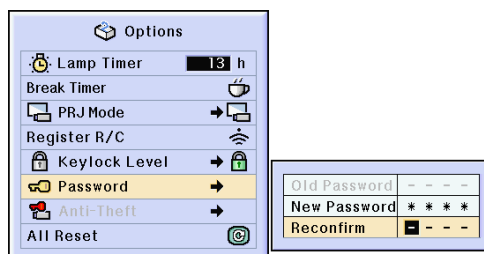
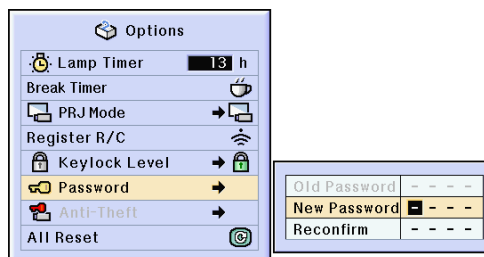



Changing the Password

Select "Password" in the "Options (2)" menu on the menu screen

→ For operating the menu screen, see pages 50 and 52.

→ For operating the menu screen using the GyroRemote see pages 54 and 55.

1 Press , and to enter the password in "Old Password" and press .

2 Press , and to set the new password and press .

3 Enter the new 4-digit password again in "Reconfirm" and press .

Note

- If you do not want to set a password, leave the fields in procedures 2 and 3 blank and press .
- To cancel the password settings, click .

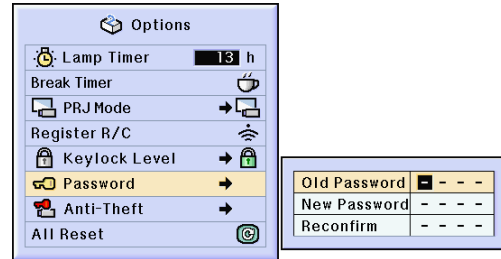

If You Forget Your Password

If you forget the password, delete it and set a new password using the following procedure.

1 Press → → → → → → .

Setting the Anti-Theft

Setting the anti-theft function will disable any projection of images even if signals are sent to the projector. A keycode is necessary to release the system lock. Make sure to remember the key code you set.

Info

If the keycode is not correctly entered in the key code field, only the key code screen will be displayed and no other operations will be possible. Repairing the system lock even within the period of guarantee will incur reparation costs. For details, refer to your nearest Sharp Representative. See page 118.



Entering the Keycode

- “Anti-Theft” cannot be selected unless “Password” is set. (See page 100.)
- When “Anti-Theft” is selected, the password input box will appear. Enter the keycode after the right password is entered.

Select “Anti-Theft” in the “Options (2)” menu on the menu screen.

→ For operating the menu screen, see pages 50 and 52.

→ For operating the menu screen using the GyroRemote see pages 54 and 55.



- 1 Press any button on the remote control or on the GyroRemote, to enter the keycode.

Note

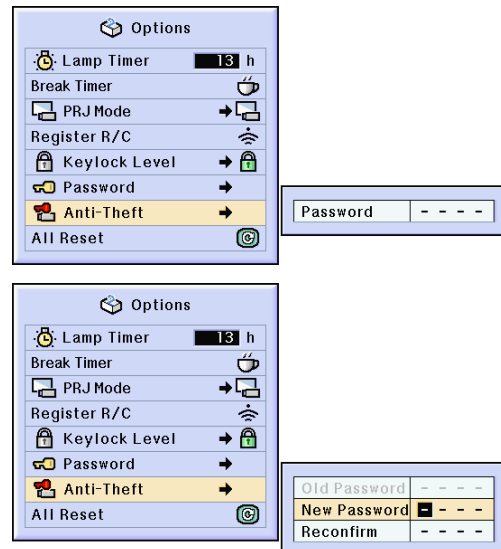
- The following buttons cannot be set as key codes. (both on the projector and GyroRemote)
 - POWER button
 - ENTER button
 - UNDO button
 - MENU button
- (GyroRemote)
 - GYRO ACTIVE button
 - POINTER button
 - L-CLICK/ENTER button
 - R-CLICK/UNDO button
 - POWER button
 - MENU button
 - TEACH button
 - RF CH+ button



2 Enter the remaining 3 digits in the same way as above and press .

3 Re-enter the same key code in  and press .

 **Note**

- The Keylock function will become temporarily disabled.

When “Anti-Theft” is set, the keycode inputting section appears after the power is turned on. At that time, enter the right keycode.

- Press the buttons on the remote control if the buttons on the remote control are used for setting the keycode. In the same manner, press the buttons on the projector if the buttons on the projector are used for setting the keycode.

 **Info**

- Once the function is activated, you must remember the correct keycode. We suggest you record the keycode in a safe place where only authorized users will have access. If you lose or forget your keycode, you will need to contact your nearest Sharp Authorized Projector Dealer or Service Center (see page 118). You may need to bring your projector to them to restore the projector to original factory condition (password and keycode reset).
- If the Anti-theft function is set and you lose the GyroRemote, you will not be able to release the Anti-theft function. In case you lose the GyroRemote, contact your nearest repair center.

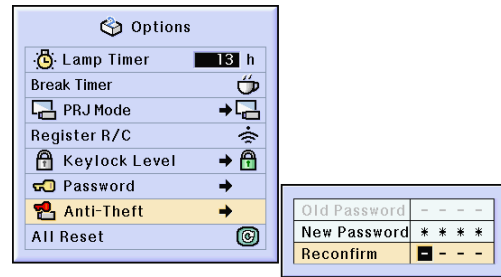

Setting the Anti-Theft (cont.)

Changing the Keycode

- When “Anti-Theft” is selected and a password has been entered, the password input box is displayed. After the password has been entered, you can change the keycode.

Select “Anti-Theft” in the “Options (2)” menu on the menu screen.

→ For operating the menu screen, see pages 50 and 52.

→ For operating the menu screen using the GyroRemote see pages 54 and 55.

1 Enter the preset 4-digit keycode in “Old Code” using the buttons on the GyroRemote or on the projector.

2 Press any button you like on the GyroRemote or the projector to enter the new keycode.

3 Enter the same 4-digit keycode in “Reconfirm” .

Note

- If you do not want to set a keycode, leave the keycode field blank in steps 2 and 3 and press .

Info

- If you travel with your projector without your GyroRemote, you will not be able to unlock the Anti-Theft keycode. Therefore, we recommend you use the projector buttons to lock/ unlock the Anti-Theft keycode.

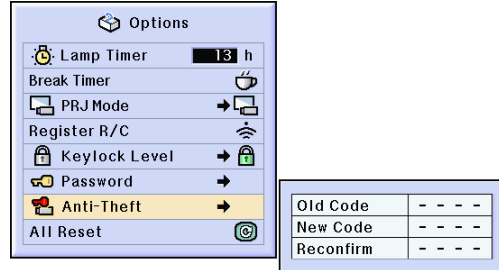

Initializing the Settings

This function allows you to initialize the settings you have made in the projector.



Returning to the Default Settings

Select “All Reset” in the “Options (2)” menu on the menu screen.

→ For operating the menu screen, see pages 50 and 52.

→ For operating the menu screen using the GyroRemote see pages 54 and 55.



Note

- If a password has been set, the password input box will be displayed when selecting “All Reset”.

The following items cannot be initialized.

- Fine Sync
 - Special Modes
 - Signal Info
- Options
 - Lamp Timer
 - Anti-Theft
- Language
- Image stored using “Image Capture”



Displaying the Adjustment Settings

This function can be used to display all the adjusted settings as a list on the screen.



Overview of ALL Menu Settings

Select the "Status" menu and press  on the menu screen.

→ For operating the menu screen, see pages 50 and 52.

→ For operating the menu screen using the GyroRemote see pages 54 and 55.

Picture	Fine Sync	Options	Options	Other
Contrast 0	Clock 0	Pict In Pict	Lamp Timer 13h	English Language
Bright 0	Phase 0	Power Save	PRJ Mode	
Red 0	H-Pos 0	sRGB	Keylock Level	
Blue 0	V-Pos 0	Auto Search	Password	Standard Gamma
CLR Temp 0	Select Setting	DNR	Anti-Theft	Normal Resize
Signal Type	Special Modes 1	OSD Display		
Progressive Mode	Auto Sync	Background		
	Auto Sync Disp	Startup Image		Serial Number
		Auto Power Off	Monitor Out	Firmware M25XXXXXX



Appendix

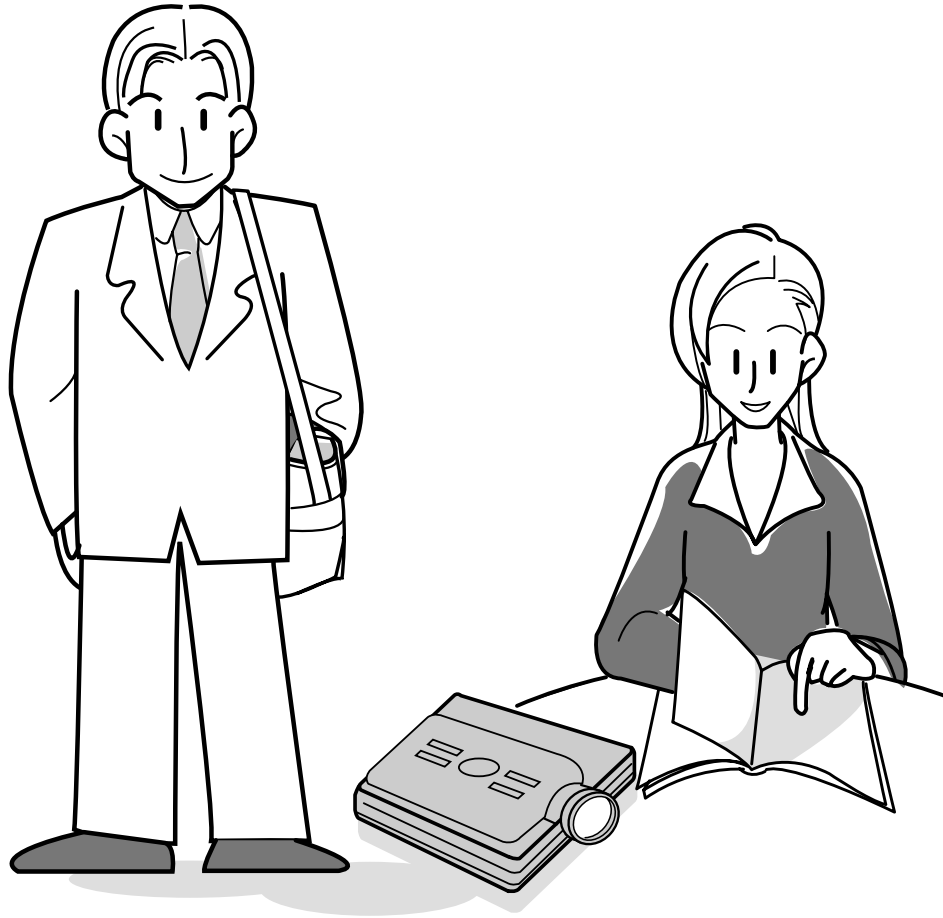



Carrying the Projector

How to Use the Carrying Case

When transporting the projector, make sure to retract the antenna, cover the lens with the lens cap, and place the projector in the included carrying case.

1 Open the cover of the carrying case.

2 Remove the inner padding from the carrying case, and fold it in the direction of the arrows.

3 Reinsert the inner padding into the carrying case.

Info

- Be sure to insert the inner padding to protect the lens and the projector.

4 Place the projector and the accessories in the carrying case.

Info

- Be sure to attach the lens cap to protect the lens.
- Be sure the projector has cooled down enough before placing it in the case.
- Make sure that the antenna for the GyroRemote is fully retracted.
- Make sure that the Eject button is fully inserted.
- Make sure to turn the off the projector.

Info

- This carrying case is only for storing and carrying the projector.
- Shipping the projector in the carrying case as a parcel may cause damage to the projector. If you ship the projector, be sure to place it in a sturdy case and with enough shock absorbing material to avoid any damage.
- Do not expose the carrying case or projector to direct sunlight, near heat sources, or in an enclosed automobile. The carrying case or projector may change color or become deformed.
- When moving the projector, make sure the Eject button is pressed all the way in. If moved with the Eject button out, the projector may be damaged.

GB-108

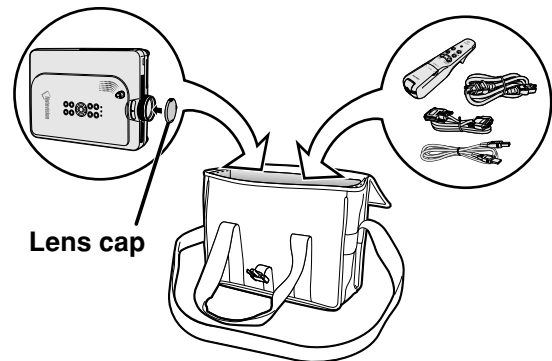
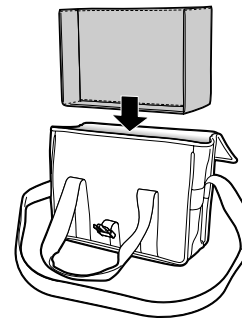
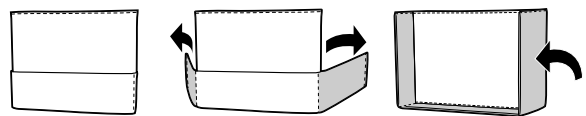
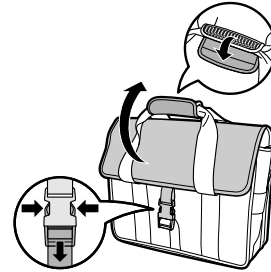

Lens cap

Adjust the shoulder strap.

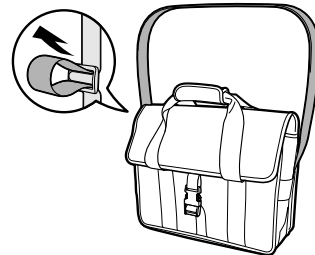



Maintenance

Cleaning the projector

- Be sure to unplug the power cord before cleaning the projector.
- The cabinet as well as the operation panel is made of plastic. Avoid using benzene or thinner, as these can damage the finish on the cabinet.
- Do not use volatile agents such as insecticides on the projector.
Do not attach rubber or plastic items on the projector for long time.
The effects of some of the agents in the plastic may cause damage to the quality or finish of the projector.

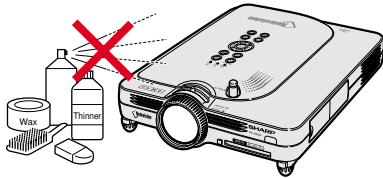

- Wipe off dirt gently with a soft flannel cloth.

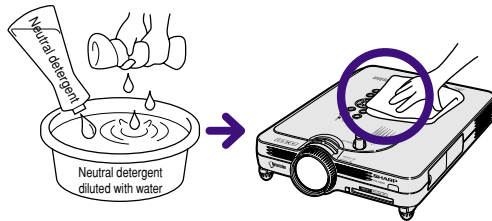

- When the dirt is hard to remove, soak a cloth in a neutral detergent diluted with water, wring the cloth well and then wipe the projector. Strong cleaning detergents may discolor, warp or damage the coating on the projector. Make sure to test on a small, inconspicuous area on the projector before using.

Cleaning the lens

- Use a commercially available blower or lens cleaning paper (for glasses and camera lenses) for cleaning the lens. Do not use any liquid type cleaning agents, as they may wear off the coating film on the surface of the lens.
- As the surface of the lens can easily get damaged, be sure not to scrape or hit the lens.

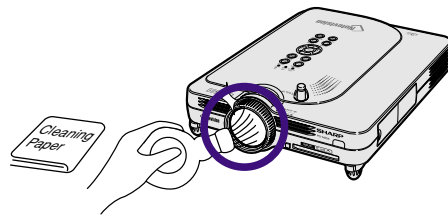

Cleaning the exhaust and intake vents

- Use a vacuum cleaner to clean dust from the exhaust vent and the intake vent.

Projector's Rear View

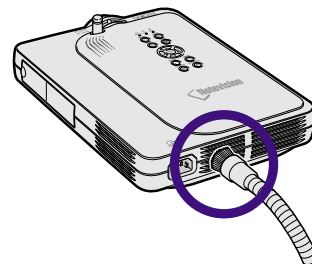

Maintenance Indicators

- The warning lights on the projector indicate problems inside the projector.
- If a problem occurs, either the TEMPERATURE WARNING indicator or the LAMP REPLACEMENT indicator will illuminate red, and the power will turn off. After the power has been turned off, follow the procedures given below.

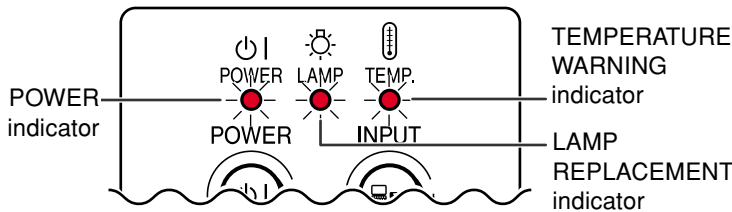

About the TEMPERATURE WARNING indicator

If the temperature inside the projector increases, due to blockage of the air vents, or the setting location, "TEMP." will blink in the lower left corner of the picture. If the temperature keeps on rising, the lamp will turn off and the TEMPERATURE WARNING indicator will blink, the cooling fan will run for further 90 seconds, then the power will be shut off. After "TEMP." appears, be sure to perform the following measures.



About the LAMP REPLACEMENT indicator



- When the lamp exceeds 1,900 cumulative hours of use, "LAMP" will be displayed on the screen in yellow. When the cumulative hours of use reach 2,000, "LAMP" will change to red, the lamp will automatically turn off and then the projector as well. At this time, the LAMP REPLACEMENT indicator will illuminate in red.
- If you try to turn on the projector a fourth time without replacing the lamp, the projector will not turn on.

Maintenance indicator		Condition	Problem	Possible Solution
TEMPERATURE WARNING indicator	Normal			
	Off	Abnormal	The internal temperature is abnormally high.	<ul style="list-style-type: none"> • Blocked air intake • Cooling fan breakdown • Internal circuit failure • Clogged air intake
LAMP REPLACEMENT indicator	Green on (Green blinks when the lamp is active.)	Red blinks	Time to change the lamp	<ul style="list-style-type: none"> • Relocate the projector to an area with proper ventilation. • Take the projector to your nearest Sharp Authorized Projector Dealer or Service Center (see page 118) for repair.
		Red on/ Power off	The lamp does not illuminate.	<ul style="list-style-type: none"> • Lamp usage time exceeded 1,900 hours • Burnt-out lamp • Lamp circuit failure

Info

- If the TEMPERATURE WARNING indicator illuminates, and the power turns off, follow the above possible solutions and then wait until the projector has cooled down completely before plugging in the power cord and turning the power back on. (At least 5 minutes.)
- If the power is turned off and then turned on again, as during a brief test, the LAMP REPLACEMENT indicator may be triggered, preventing the power from going on. Should this occur, take the power cord out of the wall outlet and plug it back in again.
- If you want to clean the air vents during projector operation, be sure to first press ^{POWER} (B1) and after the power has turned off and the cooling fan has stopped, then clean the vents.
- Do not unplug the power cord after the power has been turned off and while the cooling fan is running. The cooling fan runs for about 90 seconds.



Regarding the Lamp

Lamp

- It is recommended that the lamp (sold separately) be replaced after approximately 1,900 cumulative hours of use or when you notice a significant deterioration of the picture and color quality. The lamp usage time can be checked with the on-screen display. See page 58.
- For lamp replacement, please consult your nearest Sharp Authorized Projector Dealer or Service Center.

IMPORTANT NOTE TO U.S. CUSTOMERS:

The lamp included with this projector is backed by a 90-day parts and labor limited warranty. All service of this projector under warranty, including lamp replacement, must be obtained through a Sharp Authorized Projector Dealer or Service Center. For the name of the nearest Sharp Authorized Projector Dealer or Service Center, please call toll-free: 1-888-GO-SHARP (1-888-467-4277). U.S.A. ONLY

Caution Concerning the Lamp

- This projector utilizes a pressurized mercury lamp. A loud sound may indicate lamp failure. Lamp failure can be attributed to numerous sources such as: excessive shock, improper cooling, surface scratches or deterioration of the lamp due to a lapse of usage time. The period of time up to failure largely varies depending on the individual lamp and/or the condition and the frequency of use. It is important to note that failure can often result in the bulb cracking.
- When the LAMP REPLACEMENT indicator and on-screen display icon are illuminated or flash, it is recommended that the lamp be replaced with a new one immediately, even if the lamp appears to be operating normally.
- Should the lamp break, the glass particles may spread inside the lamp cage or gas contained in the lamp may be vented into the room from the exhaust vent. Because the gas in this lamp includes mercury, ventilate the room well if the lamp breaks and avoid all exposure to the released gas. In case of exposure to the gas, consult with a doctor as soon as possible.
- Should the lamp break, there is also a possibility that glass particles may spread inside of the projector. In such a case, it is recommended you contact your nearest Sharp Authorized Projector Dealer or Service Center to remove the damaged lamp and assure safe operation.

Replacing the Lamp

Caution

- Do not remove the lamp unit immediately after operation of the projector. The lamp will be hot and touching it can lead to burn or injury.
- Wait at least one hour after the power cord is disconnected to allow the surface of the lamp unit to fully cool before removing the lamp unit.
- If the new lamp does not light after replacement, take your projector to the nearest Sharp Authorized Projector Dealer or Service Center for repair. Purchase a replacement lamp unit of type BQC-PGM25X//1 from your nearest Sharp Authorized Projector Dealer or Service Center. Then carefully change the lamp by following the instructions described in this section. If you wish, you may have the lamp replaced at your nearest Sharp Authorized Projector Dealer or Service Center.

Regarding the Lamp (cont.)

Removing and Installing the Lamp Unit

Info

- Be sure to remove the lamp unit by the handle. Be sure not to touch the glass surface of the lamp unit or the inside of the projector.
- To avoid injury to yourself and damage to the lamp, be sure to carefully follow the steps below.
- Do not loosen other screws except for the lamp cover and lamp unit.
- Please refer to the installation manual included with the lamp unit.
- Make sure to read the manual that came included with the lamp until.

1 Press on the projector to turn off the power.

- Wait until the cooling fan stops.

⚠ Warning!

- Do not remove the lamp unit from the projector right after use. The lamp will be very hot and may cause burn or injury.

2 Disconnect the power cord.

- Unplug the power cord from the AC socket.
- Retract the antenna.
- Leave the lamp until it has fully cooled down (about 1 hour).

3 Remove the lamp unit cover.

- Insert the antenna and turn over the projector, and loosen the user service screw that secures the lamp unit cover. Then slide the cover in the direction of the arrow.

GB-112

Lamp unit

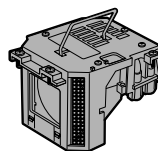

BQC-PGM20X//1

POWER button

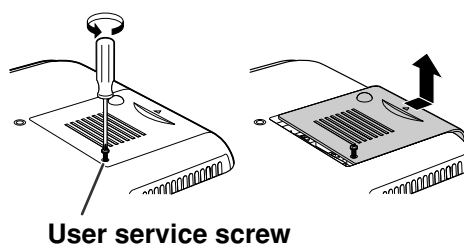
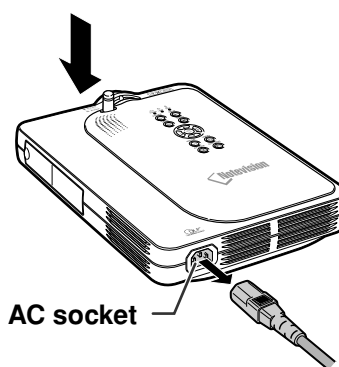
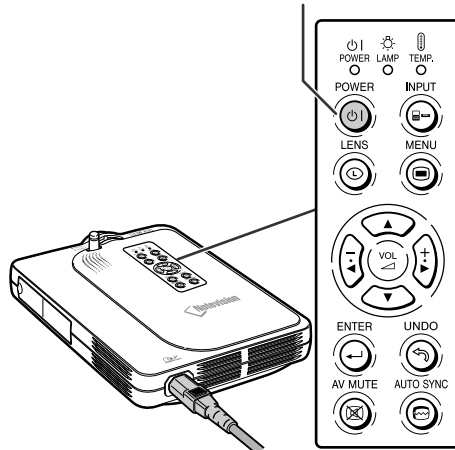

4 Loosen the lamp unit.

- Remove the securing screws from the lamp unit. Hold the lamp unit by the handle and pull it in the direction of the arrow.

5 Insert the new lamp unit.

- Press the lamp unit firmly into the lamp unit compartment. Fasten the securing screws.

6 Attach the lamp unit cover.

- Slide the lamp unit cover in the direction of the arrow. Then tighten the user service screw.

Info

- If the lamp unit and lamp cover are not correctly installed, the power will not turn on, even if the power cord is connected to the projector.

Resetting the Lamp Timer





Reset the lamp timer after replacing the lamp.

1 Connect the power cord.

- Plug the power cord into the AC socket of the projector.

2 Reset the lamp timer.

- While pressing simultaneously

, , and  on the projector, press  on the projector.

- "LAMP 0000H" is displayed, indicating that the lamp timer is reset.

Info

- Make sure to reset the lamp timer only when replacing the lamp. If you reset the lamp timer and continue to use the same lamp, this may cause the lamp to become damaged or explode.

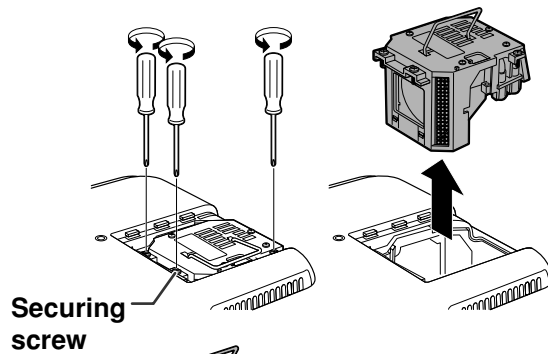

Securing screw

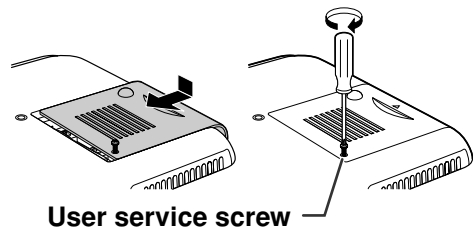
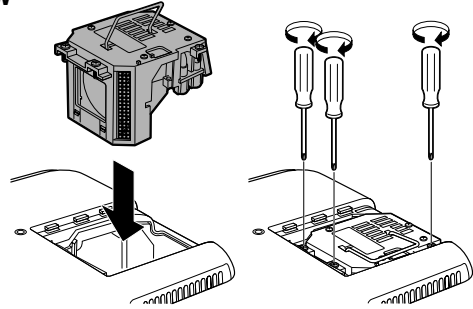

User service screw

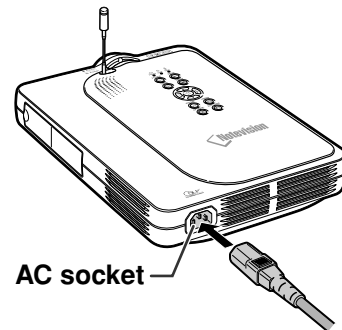

AC socket

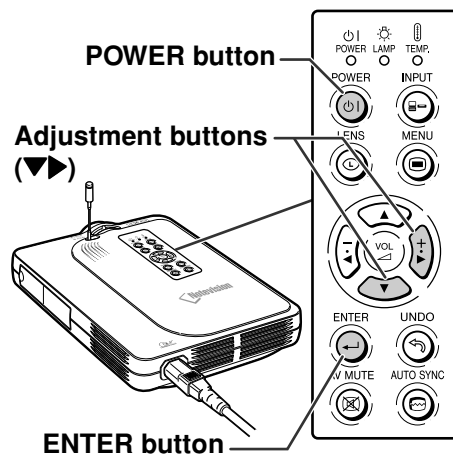

POWER button

Adjustment buttons (◀▶)

ENTER button

Connecting Pin Assignments

DVI Digital / Analog INPUT 1 port : 29 pin connector

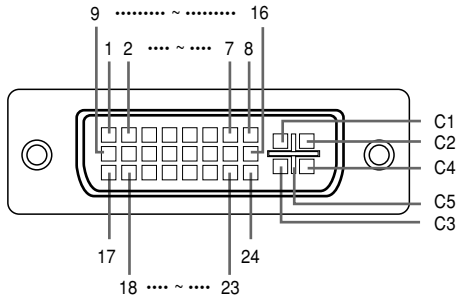

• DVI Digital INPUT

Pin No.	Signal	Pin No.	Signal
1	T.M.D.S data 2-	16	Hot plug detection
2	T.M.D.S data 2+	17	T.M.D.S data 0-
3	T.M.D.S data 2 shield	18	T.M.D.S data 0+
4	Not connected	19	T.M.D.S data 0 shield
5	Not connected	20	Not connected
6	DDC clock	21	Not connected
7	DDC data	22	T.M.D.S clock shield
8	Not connected	23	T.M.D.S clock+
9	T.M.D.S data 1-	24	T.M.D.S clock-
10	T.M.D.S data 1+	C1	Not connected
11	T.M.D.S data 1 shield	C2	Not connected
12	Not connected	C3	Not connected
13	Not connected	C4	Not connected
14	+5V power	C5	Ground
15	Ground		

• DVI Analog RGB Input

Pin No.	Signal	Pin No.	Signal
1	Not connected	16	Hot plug detection
2	Not connected	17	Not connected
3	Not connected	18	Not connected
4	Not connected	19	Not connected
5	Not connected	20	Not connected
6	DDC clock	21	Not connected
7	DDC data	22	Not connected
8	Vertical sync	23	Not connected
9	Not connected	24	Not connected
10	Not connected	C1	Analog input Red
11	Not connected	C2	Analog input Green
12	Not connected	C3	Analog input Blue
13	Not connected	C4	Horizontal sync
14	+5V power	C5	Ground
15	Ground		

• DVI Analog Component Input

Pin No.	Signal	Pin No.	Signal
1	Not connected	16	Not connected
2	Not connected	17	Not connected
3	Not connected	18	Not connected
4	Not connected	19	Not connected
5	Not connected	20	Not connected
6	Not connected	21	Not connected
7	Not connected	22	Not connected
8	Not connected	23	Not connected
9	Not connected	24	Not connected
10	Not connected	C1	Analog input Pr/Cr
11	Not connected	C2	Analog input Y
12	Not connected	C3	Analog input Pb/Cb
13	Not connected	C4	Not connected
14	Not connected	C5	Ground
15	Ground		

4-pin USB connector

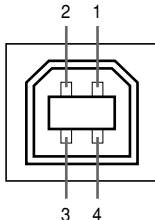

• USB connector: 4 pin B-type USB connector

Pin no.	Signal	Name
1	VCC	USB power
2	USB-	USB data-
3	USB+	USB data+
4	SG	Signal Ground



Computer Compatibility Chart

- Multiple signal support
Horizontal Frequency: 15–126 kHz
Vertical Frequency: 43–200 Hz*
Pixel Clock: 12–230 MHz
- Compatible with sync on green and composite sync signals
- UXGA and SXGA compatible in advanced intelligent compression
- AICS (Advanced Intelligent Compression and Expansion System) resizing technology

The following is a list of modes that conform to VESA. However, this projector supports other signals that are not VESA standards.

PC/MAC/WS	Resolution	Horizontal Frequency (kHz)	Vertical Frequency (Hz)	VESA Standard	DVI Support	Display		
PC	VGA	640 × 350	27.0	60			Upscale	
			31.5	70				
			37.9	85	✓			
		720 × 350	27.0	60				
			31.5	70				
			640 × 400	27.0	60			✓
	31.5	70			✓			
	37.9	85		✓	✓			
	720 × 400	27.0	60		✓			
		31.5	70		✓			
		37.9	85	✓	✓			
		640 × 480	26.2	50				
			31.5	60		✓		
			34.7	70				
			37.9	72	✓	✓		
			37.5	75	✓	✓		
			43.3	85	✓	✓		
		SVGA	800 × 600	47.9	90			
				53.0	100			
				61.8	120			
	78.5			150				
	80.9			160				
	100.4			200				
	31.4			50				
	35.1			56	✓	✓		
	37.9			60	✓	✓		
	44.5			70				
	48.1			72	✓	✓		
	46.9			75	✓	✓		
	53.7			85	✓	✓		
	56.8			90				
	64.0			100				
	77.2	120						
	98.3	150						
	102.1	160						
	125.6	200						
	XGA	1,024 × 768	35.5	43		✓		
			40.3	50				
			48.4	60	✓	✓		
			56.5	70	✓	✓		
			58.1	72				
			60.0	75	✓	✓		
			68.7	85	✓	✓		
			73.5	90				
			77.2	96				
80.6			100					
98.8			120					
113.2			140					

PC/MAC/WS	Resolution	Horizontal Frequency (kHz)	Vertical Frequency (Hz)	VESA Standard	DVI Support	Display		
PC	SXGA	1,152 × 864	54.3	60		✓	Advanced Intelligent Compression	
			64.0	70				
			64.1	72				
			67.5	75	✓	✓		
			75.7	80				
			77.3	85				
		1,152 × 882	90.2	100				
			54.8	60				
			65.9	72				
			67.4	74				
			64.0	60	✓	✓		
			74.6	70				
	1,280 × 1,024	78.1	74					
		80.0	75	✓				
		91.1	85	✓				
		108.4	100					
		SXGA*	1,400 × 1,050	64.0	60			
				74.7	52			
	75.0			60	✓			
	81.3			65	✓			
	87.5			70	✓			
	90.1			72				
	UXGA	1,600 × 1,200	93.8	75	✓			
			106.3	85	✓			
PC/MAC 13"	VGA	640 × 480	34.9	67			Upscale	
PC/MAC 19"	XGA	1,024 × 768	48.4	60	✓	✓	True	
			60.0	75	✓	✓		
PC/MAC 21"	SXGA	1,280 × 1,024	80.0	75	✓		Advanced Intelligent Compression	
MAC 16"	SVGA	832 × 624	46.8	75			Upscale	
			49.6	75				
MAC 21"	SXGA	1,152 × 870	68.5	75			Advanced Intelligent Compression	
HP (WS)		1,280 × 1,024	78.1	72				
PC (WS)		1,280 × 960	60.0	60	✓			
WS			85.9	85				
SGI (WS)		1,280 × 1,024	53.5	50				
			76.8	72				
SUN (WS)		1,152 × 900	60.9	66				
			71.9	76				





* Temporary noise may be visible with vertical frequencies above 100Hz if OSD functions are activated.

Note

- This projector may not be able to display images from notebook computers in simultaneous (CRT/LCD) mode. Should this occur, turn off the LCD display on the notebook computer and output the display data in "CRT only" mode. Details on how to change display modes can be found in your notebook computer's operation manual.
- When this projector receives 640 × 350 VESA format VGA signals, "640 × 400" appears on the screen.
- When receiving 1,600 × 1,200 VESA format signals, sampling occurs and part of the image may be cut as the image is displayed in 1,024 lines.



Troubleshooting

Problem	Check	Page
 No picture and no sound or projector does not start.	<ul style="list-style-type: none"> • Projector power cord is not plugged into the wall outlet. 	26
	<ul style="list-style-type: none"> • Power to the external connected devices is off. 	—
	<ul style="list-style-type: none"> • The selected input mode is wrong. 	35
	<ul style="list-style-type: none"> • Cables incorrectly connected to side panel of the projector. 	26–32
	<ul style="list-style-type: none"> • Remote control batteries have run out. 	17
	<ul style="list-style-type: none"> • External output has not been set when connecting notebook computer. 	—
	<ul style="list-style-type: none"> • The AV MUTE display appears. 	35
	<ul style="list-style-type: none"> • The cover of the lamp unit is not installed correctly. 	112
 Sound is heard but no picture appears	<ul style="list-style-type: none"> • Cables incorrectly connected to the side panel of the projector. 	26–32
	<ul style="list-style-type: none"> • “Bright” is set to minimum position. 	59
 Color is faded or poor	<ul style="list-style-type: none"> • Picture adjustments are incorrectly set. 	59
	(Video Input only) <ul style="list-style-type: none"> • Video input system is incorrectly set. 	93
	(INPUT 1 only) <ul style="list-style-type: none"> • Input signal type RGB/Component is incorrectly set. 	60
 Picture is blurred; noise appears	<ul style="list-style-type: none"> • Adjust the focus. 	37
	<ul style="list-style-type: none"> • The projection distance exceeds the focus range. 	23–24
	(Computer Input only) <ul style="list-style-type: none"> • Perform “Fine Sync” Adjustments (“Clock” Adjustment) • Perform “Fine Sync” Adjustments (“Phase” Adjustment) • Noise will appear depending on the computer. 	61-63 61
	<ul style="list-style-type: none"> • The “DNR” (Digital Noise Reduction) setting is not correct. 	92
 Picture appears but no sound is heard	<ul style="list-style-type: none"> • Cables incorrectly connected to side panel of projector. 	26–32
	<ul style="list-style-type: none"> • Volume is set to minimum. 	35
An unusual sound is occasionally heard from the cabinet	<ul style="list-style-type: none"> • If the picture is normal, the sound is due to cabinet shrinkage caused by a room temperature changes. This will not affect operation or performance. 	—
Maintenance indicator illuminates	<ul style="list-style-type: none"> • See “Maintenance Indicators”. 	110
Image cannot be captured	<ul style="list-style-type: none"> • The signal in INPUT 1 is not an analog RGB/Digital RGB XGA (1024 × 768) signal. Images cannot be captured if the signals are different from the above. 	94
Pict in Pict does not work	<ul style="list-style-type: none"> • The signal in INPUT 1 is set to a resolution that exceeds SXGA. • The signal in INPUT 1 is sending Component signals 480I, 480P, 720P, or 1080I. • The signal in INPUT 1 is set to interlace mode using RGB signals. 	88





Problem	Check	Page
The power cannot be turned on or off using the POWER button on the projector.	<ul style="list-style-type: none"> The key lock level is set. If level B has been set, none of the buttons will work. If level A has been set, only Input Switch, Volume and AV mute will work. 	99
The screen turns green when using the INPUT 1 component.	<ul style="list-style-type: none"> The input signal type is not correctly set. 	60
The screen turn pink when using the INPUT 1 RGB mode.	<ul style="list-style-type: none"> The input signal type is not correctly set. 	60
The card installed in the INPUT 4 terminal cannot be recognized.	<ul style="list-style-type: none"> Make sure that the card is installed. Make sure that the Link indicator on the wireless LAN PC card is lit. 	31
“Not supported” is displayed.	<ul style="list-style-type: none"> Is the card installed in the projector compatible with the projector? Is the wireless LAN PC card installed in the projector different from the wireless LAN PC card AN-WC11B? 	3 20
Picture is dark	<ul style="list-style-type: none"> The LAMP REPLACEMENT indicator is blinking in red. Replace the lamp. 	110
	<ul style="list-style-type: none"> “Monitor Out” is set to “Disable” when the RGB monitor loop-out adaptor is connected to Monitor Out. 	96
Picture is too bright and whitish	<ul style="list-style-type: none"> “Monitor Out” is set to “Yes (Y Cable)” when the RGB monitor loop-out adaptor is not connected to Monitor Out. 	96
	<ul style="list-style-type: none"> Picture adjustments are incorrectly set. 	59
The VOLUME buttons on the projector do not work	<p>The VOLUME buttons do not work when: (try the VOL+/- on the remote control)</p> <ul style="list-style-type: none"> when the menu is displayed when the lens menu is displayed when Pict in Pict is working during Enlarge (More than double size) a dot by dot screen resolution larger the panel resolution. 	—



For SHARP Assistance

If you encounter any problems during setup or operation of this projector, first refer to the “Troubleshooting” section on pages 76 and 77. If this operation manual does not answer your question, please contact the SHARP Service departments listed below.

U.S.A.	Sharp Electronics Corporation 1-888-GO-SHARP (1-888-467-4277) lcdsupport@sharpsec.com http://www.sharplcd.com
Canada	Sharp Electronics of Canada Ltd. (905) 568-7140 http://www.sharp.ca
Mexico	Sharp Electronics Corporation Mexico Branch (525) 716-9000 http://www.sharp.com.mx
Germany	Sharp Electronics (Europe) GMBH 01805-234675 http://www.sharp.de
U.K.	Sharp Electronics (U.K.) Ltd. 0161-205-2333 custinfo@sharp-uk.co.uk http://www.sharp.co.uk
Italy	Sharp Electronics (Italy) S.P.A. (39) 02-89595-1 http://www.sharp.it
Australia	Sharp Corporation of Australia Pty. Ltd. 1300-135-022 http://www.sharp.net.au
New Zealand	Sharp Corporation of New Zealand (09) 634-2059, (09) 636-6972 http://www.sharpnz.co.nz
Singapore	Sharp-Roxy Sales (S) Pte. Ltd. 65-226-6556 ckng@srs.global.sharp.co.jp http://www.sharp.com.sg
Hong Kong	Sharp-Roxy (HK) Ltd. (852) 2410-2623 dcmktg@srh.global.sharp.co.jp http://www.sharp.com.hk
Malaysia	Sharp-Roxy Sales & Service Co. (60) 3-5125678
U.A.E.	Sharp Middle East Fze 971-4-81-5311 helpdesk@smef.global.sharp.co.jp
Thailand	Sharp Thebnakorn Co. Ltd. 02-236-0170 svc@stcl.global.sharp.co.jp http://www.sharp-th.com
Korea	Sharp Electronics Incorporated of Korea (82) 2-3660-2002 webmaster@sharp-korea.co.kr http://www.sharp-korea.co.kr

GB-118

Specifications

Product type	Digital Multimedia Projector
Model	PG-M25X
Video system	NTSC 3.58/NTSC 4.43/PAL/PAL-M/PAL-N/PAL 60/SECAM/DTV480I/DTV480P/DTV720P/DTV1080I
Display method	Single Chip Digital Micromirror Device™ (DMD™) by Texas Instruments
DMD panel	Panel size: 0.7" (17.8 mm), 1 chip XGA DMD No. of dots: 786,432 dots (1,024 [H] × 768 [V])
Lens	1–1.2 × zoom lens, F1.75–2.04, f = 28.0–33.5 mm
Projection lamp	High Intensity Discharge Lamp (HID Lamp), DC 210 W
Component input signal (INPUT1)	29-pin connector DVI input signal: Digital 250–1,000 mV 50 Ω Analog 0.7 Vp-p 75 Ω Y: 1.0 Vp-p, sync negative, 75 Ω terminated P _B : 0.7 Vp-p, 75 Ω terminated P _R : 0.7 Vp-p, 75 Ω terminated
Horizontal resolution	700 TV lines (DTV720P)
Computer RGB input signal (INPUT 1)	29-pin connector RGB separate/sync on green type analog input: 0–0.7 Vp-p, positive, 75 Ω terminated HORIZONTAL SYNC. SIGNAL: TTL level (positive/negative) VERTICAL SYNC. SIGNAL: Same as above
S-video input signal (INPUT 2)	4-pin Mini DIN connector Y (luminance signal): 1.0 Vp-p, sync negative, 75 Ω terminated C (chrominance signal): Burst 0.286 Vp-p, 75 Ω terminated
Video input signal (INPUT 3)	RCA connector: VIDEO, composite video, 1.0 Vp-p, sync negative, 75 Ω terminated
Pixel clock	12–230 MHz
Vertical frequency	43–200 Hz*
Horizontal frequency	15–126 kHz
Audio input signal	ø3.5 mm MINIJACK: AUDIO, 0.5 Vrms, more than 47 kΩ (stereo)
PC card slot	PCMCIA-TYPE II
Audio output	2.0 W (monaural)
Speaker system	4 cm × 3 cm
Rated voltage	AC 100–240 V
Input current	3.2 A
Rated frequency	50/60 Hz
Power consumption	295 W
Heat dissipation	XXXX BTU/hour
Operating temperature	41°F to 95°F (+5°C to +35°C)
Storage temperature	–4°F to 140°F (–20°C to +60°C)
Cabinet	Plastic
GyroRemote Radio Frequency Range	49.825 – 49.895 MHz (for U.S., Canada etc.), 40.667 – 40.695 MHz (for Europe, Oceania, Asia)
Dimensions (approx.)	8 5/8" × 3" × 11 15/16" (219 (W) × 76 (H) × 303 (D) mm) (main body only) 8 3/4" × 3 1/4" × 12 1/2" (223 (W) × 83 (H) × 318 (D) mm) (including adjustment feet and projecting parts)
Weight (approx.)	5.8 lbs. (2.6 kg)
Supplied accessories	GyroRemote for U.S., Canada etc., GyroRemote for Europe, Australia, Oceania and Asia, Four R-03 batteries, Power cord for U.S., Canada etc. (6', 1.8 m), Power cord for Europe, except U.K. (6', 1.8 m), Power cord for U.K., Hong Kong and Singapore (6', 1.8 m), Power cord for Australia, New Zealand and Oceania (6', 1.8 m), DVI to 15-pin D-sub cable (6', 1.8 m), USB cable (6', 1.8 m), Carrying case, Lens cap (attached), Lens cap strap, Terminal cover (attached), CD-ROM, Operation manual, Quick reference guides, Wireless Reality operation manual, Wireless LAN PC Card IMPORTANT INFORMATION.
Replacement parts	Lamp unit (Lamp/cage module) (BQC-PGM20X//1), GyroRemote for U.S., Canada etc. (RRMCG1631CESA), GyroRemote for Europe, Australia, Oceania and Asia (RRMCG1653CESA), Four R-03 batteries ("AAA" size, UM/SUM-4, HP-16, or similar), Power cord for U.S., Canada etc. (QACCCA007WJPZ), Power cord for Europe, except U.K. (QACCV4002CEZZ), Power cord for U.K., Hong Kong and Singapore (QACCB5024CENA), Power cord for Australia, New Zealand and Oceania (QACCL3022CEZZ), DVI to 15-pin D-sub cable (QCNWGA010WJZZ), USB cable (QCNWG0001WJPZ), Two wireless LAN cards (AN-WC11B), Carrying case (GCASN0005CESA), Lens cap (CCAPHA001WJ01), Lens cap strap (UBNDT0013CEZZ), Terminal cover (GCOVD0103CESA), CD-ROM (UDSKA0058CEN1), Operation manual (TINS-A046WJZZ), Quick reference guides, Wireless LAN PC Card IMPORTANT INFORMATION.

* Temporary noise may be visible with vertical frequencies above 100Hz if OSD functions are activated.

This SHARP projector uses a DMD panel. This very sophisticated panel contains 786,432 pixels. As with any high technology electronic equipment such as large screen TVs, video systems and video cameras, there are certain acceptable tolerances that the equipment must conform to.

This unit has some inactive pixels within acceptable tolerances which may result in inactive dots on the picture screen. This will not affect the picture quality or the life expectancy of the unit.

Specifications are subject to change without notice.

Wireless LAN PC Card Specification

Product Name	11 Mbps Wireless LAN PC Card
Model Number	AN-WC11B
Host Interface	PCMCIA TYPE II
Dimensions	4 ½" × 2 ⅛" × ¼" (115 × 54 × 7 mm)
Weight	40 g
Frequency Band (Central frequency)	2.412 – 2.462 GHz
Number of Channel	Channels that can be used vary depending on the country.
Operating Voltage	3.3 V ± 5% or 5 V ± 5%
Current Consumption	Typ. 240 mA, Max. 300 mA
Spreading	DS SS (Direct Sequence Spread Spectrum)
Data rate	11 Mbps, 5.5 Mbps, 2 Mbps, 1 Mbps (Auto-Switch)
Transmit Power	10 dBm @Nominal Temp Range 13 dBm (Max)
Receive Sensitivity	Nominal Temp Range: 11 Mbps 10-5 BER @-81 dBm, minimum
Modulation	11 Mbps and 5.5 Mbps CCK: 2 Mbps: DQPSK: 1 Mbps: DBPSK:
Security	64-bit WEP (128-bit optional) (not compatible with the projector)
Standards	IEEE 802.11b, Wi-Fi compliant
Media Access Protocol	CSMA/CA with ACK
Temperature Range	0 to 55°C (Operating), -20 to 65°C (Storage)
Humidity	Max. 95% Non-condensing
Operating Range	Open Space: 2 ⅜" to 4 ¾" (60 to 120 m); Indoor: 1 ⅜" to 2 ⅜" (30 to 60 m) The transmission speed varies in the surrounding environment. The transmission distance varies with the transmission.



Usable Cards and Their Capacity

1. JPEG images that are DCF compliant *1 and are stored in a memory card such as those from a digital camera, can be displayed in the projector when using the Card mode.

For details on the Card Mode, see page XX.

2. The memory cards in the following table (commercially available) can be used.

Memory Card *2	Memory card capacity
Flash ATA card	under 128MB can be used.
SD memory card	under 128MB can be used.
CompactFlash	under 128MB can be used.
Multimedia card	under 64MB can be used.
Smart media	under 128MB can be used.
Memory stick	under 128MB can be used.

* Each memory card requires a suitable PC Card Adapter.

Caution

- (1) Operation cannot be guaranteed for other memory cards except for those mentioned above.
- (2) PC Card Adapters may have special regulations according to the memory cards. For details, see the PC Card Adapter's operation manual.
- (3) In some cases, part of images edited on your computer may not be played.

*1 DCF standard stands for Design rule for Camera File system.

- *2
- SD memory card is a trademark.
 - CompactFlash is a trademark of San Disk Corporation.
 - Multimedia Card is a trademark of Infineon Technologies AG.
 - Smartmedia is a trademark of Toshiba Corporation.
 - Memory stick is a trademark of Sony Corporation.



Dimensions

Units: inches (mm)

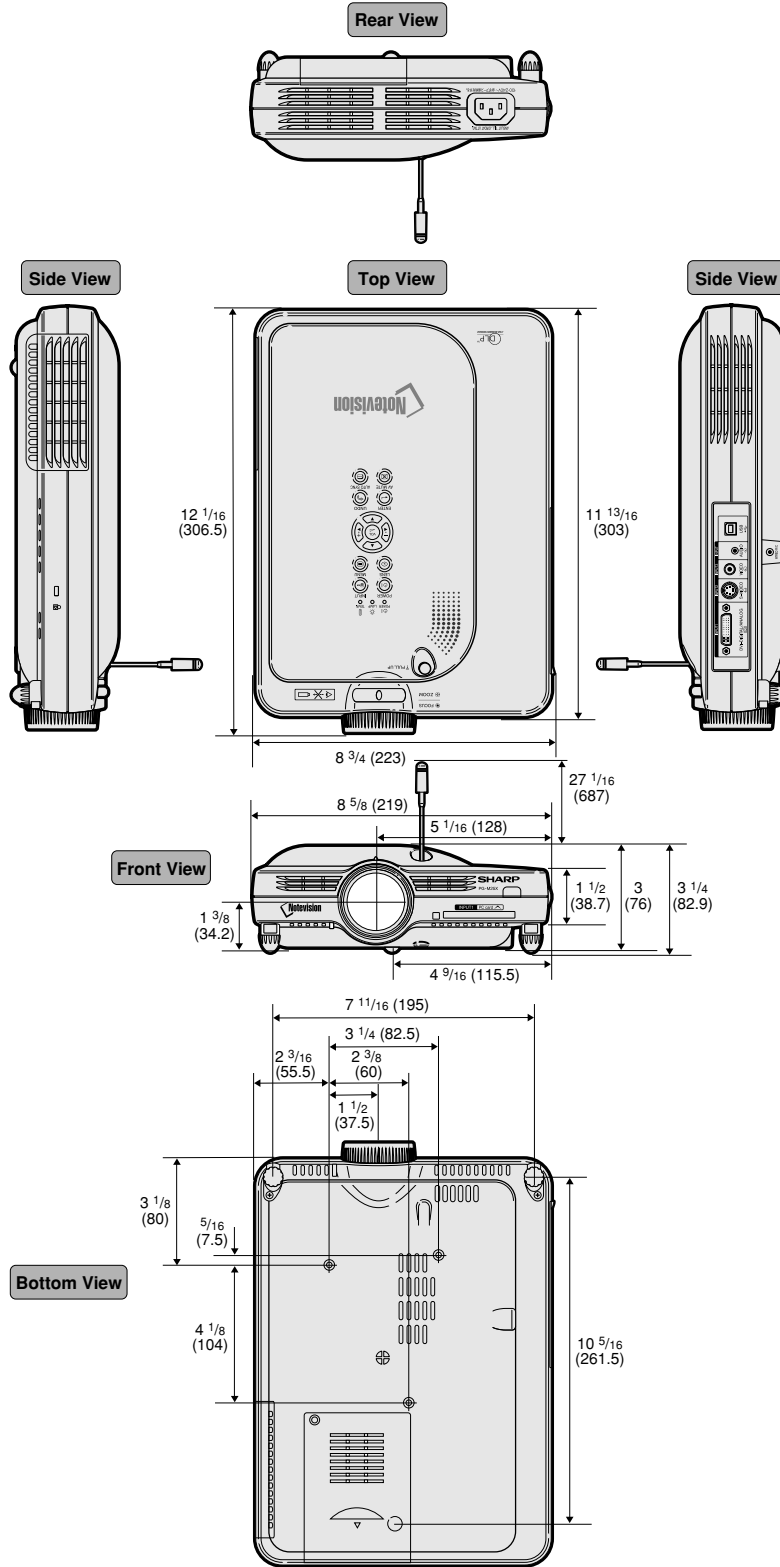

GB-122

Glossary

Advanced intelligent compression

High quality resizing of lower and higher resolution images to fit the projector's native resolution.

Anti-theft

If the "Keycode" set in the projector is not correctly entered, the projector will not operate even if signals are entered.

Aspect Ratio

Width and height ratio of an image. The normal aspect ratio of a computer and video image is 4:3. There are also wide images with an aspect ratio of 16:9 and 21:9.

Auto Sync

Optimizes projected computer images by automatically adjusting certain characteristics.

Background

Initial setting image projected when no signal is being output.

Border

Projects a 4:3 image fully within a 16:9 screen by keeping the aspect ratio at 4:3.

Clock

Clock adjustment is used to adjust vertical noise when clock level is incorrect.



CLR Temp (Color temperature)

Function that can be used to adjust the color temperature to suit the type of image input to the projector. Decrease the color temperature to create warmer, reddish images for natural flesh tones, or increase to create cooler, bluish images for a brighter picture.

DHCP

Stands for Dynamic Host Configuration Protocol. Procedure that automatically assigns network settings such as IP addresses from the server.

Digital Shift

Shifts image up or down easily by ,  buttons when RESIZE mode of input image is BORDER, STRETCH or SMART STRETCH of the video or the DTV signals.

Dot by dot

Mode that projects images in their native resolution.

DVI (Digital Visual Interface)

Display digital interface that also supports Analog interfaces.

Freeze

Temporarily freezes a moving image.

GAMMA

Image quality enhancement function that offers a richer image by brightening the darker portions of the image without altering the brightness of the brighter portions. You can select four different modes: STANDARD, PRESENTATION, CINEMA and GAME.

IEEE802.11b

International communication standard for wireless LANs.

IP Address

Stands for Internet Protocol address. Code number for identifying devices connected to the network. It is displayed as 192.168.0.1 where every fourth digit is a period.

Keylock Level

Mode that can lock the operation of projector buttons to prevent mischief.

Keystone correction

Function to digitally correct a distorted image when the projector is set up at an angle, smoothens out jaggies on keystone images and compresses the image not only horizontally but vertically keeping the 4:3 aspect ratio.

Password

A password is set so that changes cannot be made in the settings of the "Options (2)" menu.

Phase

Phase shift is a timing shift between isomorphic signals with the same resolution. When phase level is incorrect, the projected image typically displays horizontal flicker.

Picture in Picture

Allows you to add video images onto a data screen image, providing you with even more effective presentations.

Progressive Mode

The progressive display projects a smoother video image. You can select three different modes: 2D Progressive, 3D Progressive and Film Mode.

Projector name

Name for identifying the projector. You can any desirable name using a combination of alphanumeric characters or symbols (max. 15 characters).

RESIZE

Allows you to modify or customize the picture display mode to enhance the input image. You can select six different modes: NORMAL, FULL, DOT BY DOT, BORDER, STRETCH and SMART STRETCH.



Smart Stretch

Projects the image fully in a 16:9 screen by enlarging only the surrounding areas while keeping the aspect ratio in the middle part of the image at 4:3.

sRGB

An international standard of color reproduction regulated by the IEC (International Electrotechnical Commission). As the fixed color area has been decided by the IEC, the color changes according to DLP features, so that the images are displayed in a natural tint based on an original image, when switching to the “sRGB” mode.

SSID

Stands for Service Set ID. Name for identifying “Groups” of devices connected to a wireless LAN. Wireless data transmissions can be done only with devices that carry the same SSID (group name). You can set any desirable SSID using a combination of alphanumeric characters or symbols (max. 32 characters).

Startup Image

The image displayed when the projector is turned on.

Status function

Displays the settings of each adjustment item.

Stretch

Mode that stretches the 4:3 image horizontally to display it fully on a 16:9 screen.

Wireless channel

A wireless channel is a frequency used by wireless LAN cards in wireless communications. If other wireless LAN networks are in use near the location of the projector, make sure that different channels have been set on both the projector and the wireless LAN so as to avoid interference.

WiFi

Product brand compliant to WiFi IEEE802.11b.



Index

2D Progressive	60	LED lamp	37
3D Progressive	60	Lens adjustment	16
AC socket	26	LENS button	38
Adjustment buttons	14	Lens cap	108
Adjustment feet	22	Lens cap strap	15
All Reset	100	MENU button	50
Anti-Theft	102	Monitor Out	32
Aspect ratio	83	Mute	36
ASSIGN button	16	NORMAL	83
Auto Power Off	87	Optional accessories	20
Auto Search	91	OSD Display (On-screen display)	89
Auto Sync adjustment	63	Password	100
AUTO SYNC button	14	PC card	31
Auto Sync Display	64	PDF	13
AV MUTE button	14	Phase	61
Background image	95	Pict in Pict	88
Batteries	17	Picture adjustments	59
BORDER	83	POINTER button	16
Break Timer	97	POWER button	14, 16
Carrying case	108	Power cord	20
Ceiling-mount	25	POWER indicator	14
Clock	61	Power Save Mode	87
CLR Temp (Color Temperature)	59	PRJ mode	98
Color Management	90	Progressive Mode	60
Computer images adjustment	62	R-CLICK/UNDO button	16
DHCP server	63, 73	Replacing the lamp	111
Digital Shift	39	Reversing/Inverting Images	98
DNR	92	RGB input	60
DOT BY DOT	83	RF CH+ button	16
DVI to 15-pin D-sub cable	27	Save Setting	61
Eject button	31	Select Setting	62
ENTER button	14	Signal Info	63
Exhaust vent	15	Signal Type	59
Film Mode	60	SMART STRETCH	83
Fine Sync	62	Speaker	14
Focus ring	14	Special Mode settings	62
Foot releases	22	sRGB	90
FREEZE button	81	SSID	71
Gateway	70	Startup image	93
GYRO ACTIVE button	16	Status	106
Gyro Antenna	14	STRETCH	83
GyroRemote	16, 18, 40	Subnet Mask	70
Image Capture	94	Supplied accessories	20
INPUT AUDIO terminal	15	TEACH button	16
INPUT 1 terminal	15	TEMPERATURE WARNING indicator	110
INPUT 1 – 4 modes	35	Terminal cover	20
INPUT 2 terminal	15	TCP/IP	70
INPUT 3 terminal	15	UNDO button	14
INPUT 4 terminal	15	USB cable	47
INPUT button	14, 16	USB port	15
IP Address	66, 70	VOLUME buttons	14
Kensington Security Standard connector	38	Wireless LAN PC card	31
Keylock level	99	Wireless Presentation	16
Keystone correction (adjustment)	38	Wireless terminal for the GyroRemote	16
Lamp	110	Zoom knob	14
LAMP REPLACEMENT indicator	110		
Lamp Timer	113		
Language selection	37		
L-CLICK/ENTER button	16		



SHARP®
SHARP CORPORATION